



DigiBook 300r2

Operator Manual



rel. 03.00

Summary

1	INTRODUCTION	5
1.1	SYMBOLS OF SAFETY	7
1.2	SYMBOLS OF PROHIBITION AND OBLIGATORINESS	8
1.3	THE SAFETY DURING THE USE OF THE MACHINE	9
1.3.1	<i>general</i>	9
1.3.2	<i>SAFETY WARNINGS</i>	9
1.4	SAFETY CLOTHING	10
1.5	INSTALLATION OF ELECTRICAL CABLES AND PIPES	11
1.6	SAFETY EQUIPMENTS IN THE PERFECT BINDER	11
1.6.1	<i>Emergency button</i>	11
1.6.2	<i>Green button for start cycle</i>	12
1.6.3	<i>SAFETY light curtains</i>	12
1.6.4	<i>Protection plate of the milling station</i>	13
1.6.5	<i>MAIN SWITCH</i>	13
1.7	RISKS	14
1.8	PURPOSE	15
1.8.1	<i>uses not provided, uses prohibited</i>	15
2	TECHNICAL SHEET MASTERBOOK300	16
2.1.1	<i>Electrical</i>	18
2.1.2	<i>Pneumatics</i>	18
	<i>Air quality provided to the Perfect Binder</i>	19
	<i>DIN ISO 8573-1 - air quality class</i>	19
3	ACCESSORIES	20
4	TRANSPORTATION	21
5	STORAGE	23
6	LAYOUT	24
7	POSITIONING AND WORKSPACES	24
8	INSTALLATION	26
8.1	TECHNICAL STAFF FOR THE INSTALLATION	26
8.2	PHYSICAL CHARACTERISTICS OF THE AREA OF PLACEMENT	26
8.3	SUPPORT SURFACE	26
8.4	WEATHER PROTECTION	26
8.5	LIGHT	27
8.6	ENVIRONMENTAL CONDITIONS	27
8.7	ELECTRICAL CONNECTION	28
8.7.1	<i>Ground connection</i>	28

9 TRAINING OF THE OPERATOR	29
10 POWER ON	30
10.1 FUNDAMENTALS	31
10.2 ELECTRICAL CONNECTION	33
10.3 PNEUMATIC CONNECTION	33
10.4 DESCRIPTION OF THE GROUPS	34
10.5 CHIPS ASPIRATOR	37
10.7 PUR TANK OPENING AND CLOSING, AND GLUE LOADING.	39
10.7.1 <i>Opening of the PUR tank</i>	39
WARNINGS ON THE OPENESS OF PUR TANK	39
10.7.2 <i>preparation and loading of the pur glue</i>	41
10.7.3 <i>Cleaner loading</i>	43
11 FUNCTIONS OF THE PERFECT BINDER	45
11.1 HOME PAGE	ERROR! BOOKMARK NOT DEFINED.
11.2 HOME PAGE	ERROR! BOOKMARK NOT DEFINED.
11.3 NAVIGATION MENU OF THE PARAMETER PAGES	ERROR! BOOKMARK NOT DEFINED.
11.4 FAST CONFIGURATION OF THE BOOK	ERROR! BOOKMARK NOT DEFINED.
11.4.1 <i>Navigation Through the menus</i>	<i>Error! Bookmark not defined.</i>
11.4.2 <i>Page to display production meters</i>	<i>Error! Bookmark not defined.</i>
12 PAGE FOR TIMER MANAGEMENT	ERROR! BOOKMARK NOT DEFINED.
13 PAGES OF ALARMS	ERROR! BOOKMARK NOT DEFINED.
14 PARAMETERIZATION OF EACH GROUP	51
14.1 PARAMETER OF CLAMP / FEEDER	ERROR! BOOKMARK NOT DEFINED.
14.2 PARAMETER OF THE MILLING STATION	ERROR! BOOKMARK NOT DEFINED.
14.3 PARAMETER OF THE GLUE HEAD	ERROR! BOOKMARK NOT DEFINED.
14.4 TEMPERATURE OF THE HEAD AND THE PRE-MELTING UNIT	ERROR! BOOKMARK NOT DEFINED.
14.4.1 <i>Head glue processing information</i>	<i>Error! Bookmark not defined.</i>
14.5 PARAMETER OF THE PRESS	ERROR! BOOKMARK NOT DEFINED.
14.6 PARAMETER OF THE COVER	ERROR! BOOKMARK NOT DEFINED.
15 ACCESS TO THE PAGES OF THE MANUAL HANDLING	ERROR! BOOKMARK NOT DEFINED.
15.1 MANUAL MOVEMENTS OF THE CLAMP	ERROR! BOOKMARK NOT DEFINED.
MANUAL MOVEMENTS OF THE FEEDER	ERROR! BOOKMARK NOT DEFINED.
15.2 MANUAL MOVEMENTS OF THE MILLING STATION	ERROR! BOOKMARK NOT DEFINED.
15.3 MANUAL MOVEMENTS OF THE GLUE HEAD	ERROR! BOOKMARK NOT DEFINED.
15.4 MANUAL MOVEMENTS OF THE PRESS	ERROR! BOOKMARK NOT DEFINED.
15.5 MANUAL MOVEMENT OF THE COVER	ERROR! BOOKMARK NOT DEFINED.
16 OPERATION OF THE SYSTEM IN STANDBY	ERROR! BOOKMARK NOT DEFINED.
17 CLEANING USING CLEANER AND LOADING GLUE	ERROR! BOOKMARK NOT DEFINED.
18 PAGE OF JOB MANAGEMENT	ERROR! BOOKMARK NOT DEFINED.

18.1	PAGE OF JOB MANAGEMENT	ERROR! BOOKMARK NOT DEFINED.
19	GLUE RECOVERY PROCEDURE	64
20	COVER POSITIONING	67
	PREPARATION OF THE MACHINE TO PRODUCE A BOOK.	69
21	CLEANING THE MACHINE	72
21.1	PROCEDURE TO CLEAN THE SPINE GLUE EXTRUDER.	73
21.2	PROCEDURE TO CLEAN THE GLUE SIDE EXTRUDERS.	75
21.3	“END OF JOB” CLEANING	78
21.4	DETAILS CLEANING	80
22	PROBLEMS - SOLUTIONS	83
22.1	CHIPS ASPIRATOR - LESS VACUUM:	83
22.2	CLAMP - IT DOES'T START:	83
22.3	IRREGULAR GLUE START / STOP :	83
22.4	MILLING STATION - IRREGULAR CUT AND NOTCHING:	83
22.5	COVER PLATE MILLING STATION - IT DOES'T OPEN / CLOSE CORRECTLY:	83
22.6	HEAD - OUT OF TOO MUCH OR LITTLE GLUE:	83
22.7	PRESS	84

1 INTRODUCTION



THE READING OF THIS OPERATOR AND MAINTENANCE MANUAL IS FUNDAMENTAL FOR THE SAFETY OF THE USER AND FOR THE PROPER USE OF THE EQUIPMENT.

We thank you to have bought our product. This machine has been designed specifically for your job and your applications, and provides a high quality production and a wide range of functions.

This manual describes how to use the machine, starting from the configuration phase to the most important operations. This manual has been written in order to be easily understood also by user not trained about the use of this kind of machine. For the best use of the equipment, please read carefully this manual before to use the machine. After reading, we suggest saving the manual in a safety place and don't hesitate to read him when necessary.

DECLARATION THAT THE MACHINE IS IN SPECIFICATION TO THE EEC
DIRECTIVE CONTROLLING THE MACHINES 2006/42/CE,
(AND FOLLOWING EEC DIRECTIVES)

We declare that the production of:

Product: Perfect Binder

Model/Type: **Digibook 300**

Serial Number: **MB300-....**

Year of construction: **2012**

Follows the actual releases of the EEC Controlling Directives:

EEC Directive 2006/42/CE;

EMC Directive 89/336/CEE;

Directive controlling the Low Voltage 2006/95/CEE

And in particular the following Directives:

EN 1010

EN 60 204-1

EN 61 000-6-2, EN 61 000-6-3, EN 61 000-6-4

Assago , (MI) Italy

___/___/2012

K.G.S. S.R.L.





SAFETY

1.1 SYMBOLS OF SAFETY

In the manual some symbols are used to inform about dangerous situations for people and/or things.

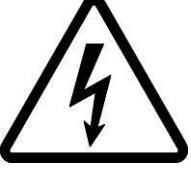

The following symbols mean dangerous situations for people and/or things.

If you don't follow carefully the appropriate procedures, damages can occur to people and/or things and in extreme situations also fatal accidents. Together with the symbols it is written also what to do.

	Attention - General danger!
	Attention - Electrical voltage! Risk of electric shock.
	Attention - Sharp blades! Risk of cut.
	Attention - Hot surfaces! Risk of burn.
	Attention - Risk of rolling parts! Risk of crushing.
	Attention - Risk of moving chain! Risk of crushing.

	In case of not warning of the symbols damages, also great, can happen to the machine and to the accessories.
---	--

1.2 SYMBOLS OF PROHIBITION AND OBLIGATORINESS

	This symbol means a prohibition.
	This symbol means an imperative.
	This symbol means that it is mandatory to read in this manual information regarding specific topics (for ex. related to the specifications of the electric and pneumatic connection).

1.3 THE SAFETY DURING THE USE OF THE MACHINE



1.3.1 GENERAL

The manufacturer guarantees that the contents of this manual are in specification with the procedures required by the machine. The manufacturer therefore will be not responsible if the machine will be used in a different way.

1.3.2 SAFETY WARNINGS

Before the use of the machine, please read carefully the manual.
Save the manual for further needs.

By apply different procedures, and not the specific procedures described in the manual, can produce operational problems.
Please, read carefully the following Safety rules.

 	<p>It is forbidden to use the machine when occurs one of the following situations:</p> <ul style="list-style-type: none"> in explosive environment; in flammable atmosphere; in excessive dust environments.
	<p>Danger! Failure to comply with some or all the instructions listed in this manual could cause damage to the machine and / or personal injury. The manufacturer is not responsible for an arbitrary and improper use of the machine such as:</p> <ul style="list-style-type: none"> Using the machine by untrained personnel; Use contrary to law; Incorrect installation; Defects in electrical power and / or pneumatic; Partial or total failure to comply with the instructions; Lack of maintenance and / or use of aftermarket parts; Changes or other actions not authorized by the manufacturer;

1.4 SAFETY CLOTHING

Clothing to use during the cleaning and /or maintenance operations

	<p>Eye protection against any spray of PUR glue or high temperature cleaner</p> <p>Respiratory Mask</p> <p>Protective gloves</p>
---	--

Tight clothing, to avoid that they remain engaged with protruding parts.

Long hair must be covered or otherwise collected by using e. g. a protective screen.

Do not wear watches or jewels.

Safety clothing

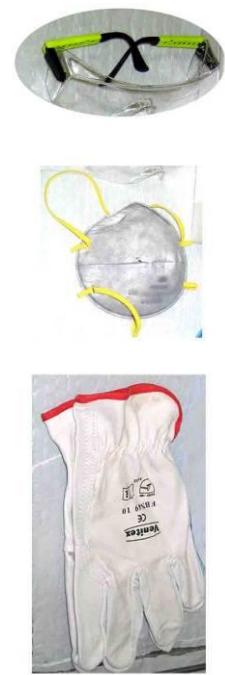
	<p>The safety clothing IS NOT INCLUDED in the machine and must be procured by the machine user.</p> <p>The operator should wear clothing appropriate to the situation and specially during the following operations:</p> <ul style="list-style-type: none"> -Maintenance -Replacing of the PUR glue -Cleaning of the PUR system <p>a) Eye protection against any spray of PUR glue or high temperature cleaner</p> <p>b) Respiratory Mask</p> <p>c) Protective gloves for high temperature</p>
--	---

1.5 INSTALLATION OF ELECTRICAL CABLES AND PIPES





Cables and pipes must be put inside of special cable channels to avoid the people to stumble and get hurt.

1.6 SAFETY EQUIPMENTS IN THE PERFECT BINDER

	<p>DANGER! It is forbidden to remove or render ineffective the safety guards for the safety of persons, and to tamper and / or modify, even partially, safety devices installed on the machine. In case of alarm signals due to the intervention of the safety, the operator must request the immediate intervention of technical people trained on the maintenance. The manufacturer is not responsible of any damage to persons or animals caused by tampering with the guards."</p>
---	---

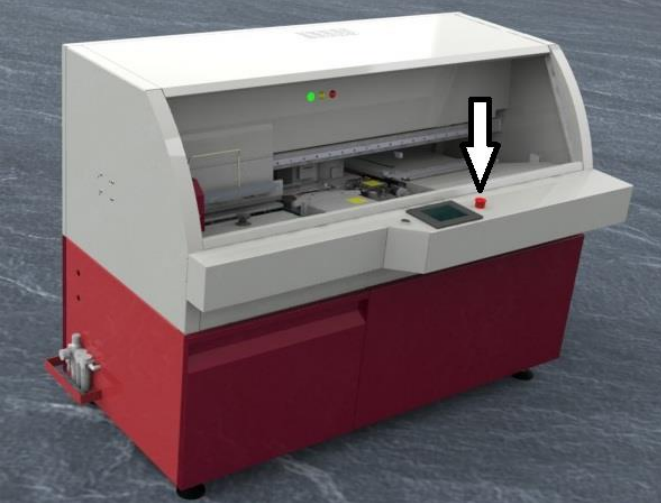
1.6.1 EMERGENCY BUTTON

It is located on the front, easily accessible from the operator's position.

	<p>In the diagrams the emergency button is identified 15S1</p> 
<p>Activation state of emergency: the push-button must be pressed</p>	<p>OFF state emergency stop: the button must be turned clockwise"</p>
	

1.6.2 GREEN BUTTON FOR START CYCLE



The green button executes the command to start cycle, it means that the clamp closes and moves to the right, the mill if activated will run the cut, the glue will be applied, and if the press has been activated will crush the book; all this happens if I put the book block in the clamp and place a cover on the press.

1.6.3 SAFETY LIGHT CURTAINS

Two safety light curtains are placed at the ends of the binder.

In case of occupation of the work place during the production cycle, the machine stops instantly in a state of emergency, preventing and avoiding of shocking or crushing objects or hands or arms of the operator.



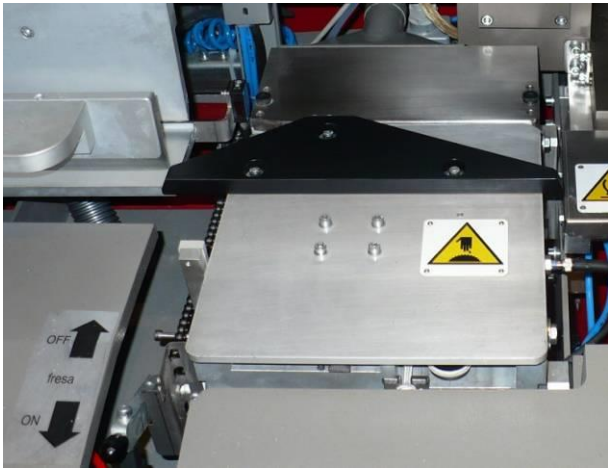
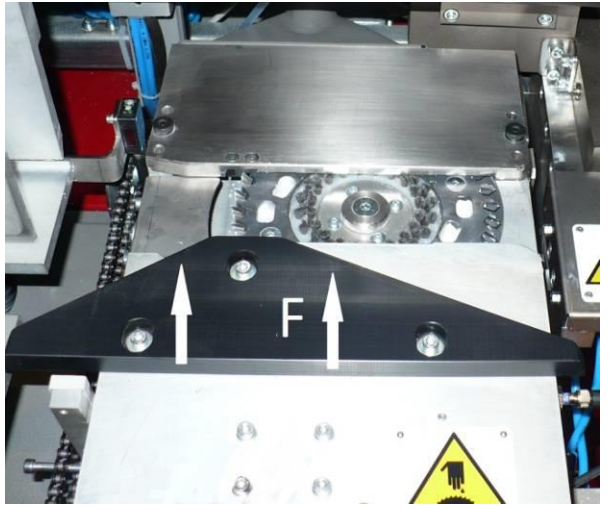

In the diagrams the SAFETY curtains are identified in the following way:
 Left SAFETY curtain 15SS2, right SAFETY curtain 15SS1

1.6.4 PROTECTION PLATE OF THE MILLING STATION

<p>The plate consists of a mobile plate that, except when the book block is moving, covers the cutter in all operating conditions, even at a standstill.</p>	<p>An elastic cord exerts constantly on the plate (F) a force (see arrows) that covers the mill disc. A sensor monitors and the cutter stops if the guard is opened, the motor of the cutter is also equipped with a brake."</p>
	



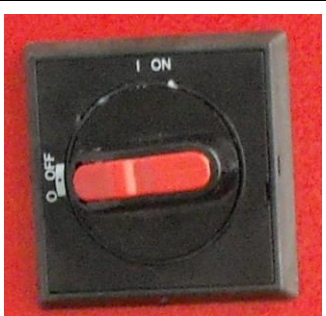



1.6.5 MAIN SWITCH

It is located on the left side of the machine.

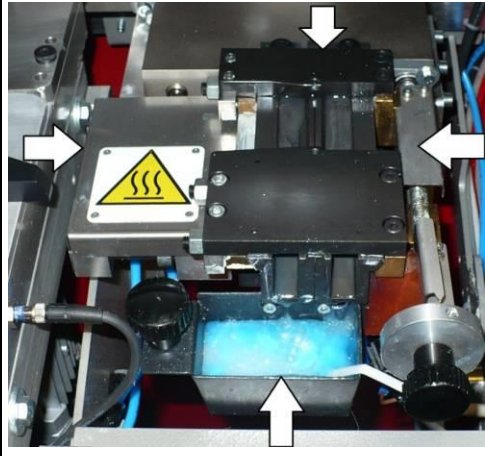
	<p>Position OFF The switch is open. The machine is off.</p>	
	<p>Position ON The switch is closed. The machine is on.</p>	

1.7 RISKS

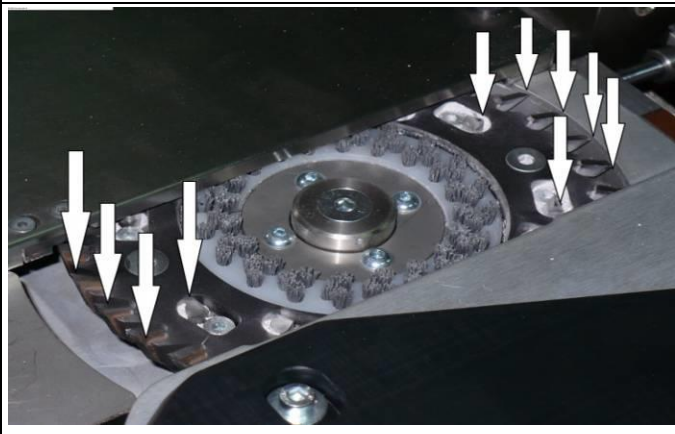
There are risks that cannot be completely eliminated by either protective or as designed by the machine.

		<p>Area of the glue head.</p> <p>Attention - Hot surfaces! Risk of burn. Use protective gloves.</p>
		<p>Area of glue loading.</p> <p>Attention - Hot surfaces! Risk of burn. Use protective gloves.</p>
		<p>Area of the mill.</p> <p>The disc contains several types of milling cutters. Use protective gloves, in case of removing the Notching Roughening or the brush.</p>



1.8 PURPOSE

The machine is used to bind books using the following materials:

- a) Signatures, or sheet of paper (printed or not) for the block book
- b) Cardboard as cover of the book

Within the limits specified in the data sheet, included in this manual.

1.8.1 USES NOT PROVIDED, USES PROHIBITED

	<p>Any other use such as,</p> <ul style="list-style-type: none"> - Milling / Roughening of book spines already binder (Adhesive binder, stitching book, Sewing Book, etc.) - Use of materials other than those specified in a) and b) - Operations beyond the technical specifications are not to be regarded as intended use. 	
--	--	--

The user has the total responsibility of the damages to people or things due to an improper use, outside of their intended use.

2 TECHNICAL SHEET Digibook 300

Machine features:

Cycle/Hour	300 mechanical cycles
Spine length	100 - 450 mm
Workable height of the book	120 - 320 mm
Max. Cover size	710x460/240x110 mm
Workable thickness of the book	2 - 50 mm
Max. Cover Weight	500 g/m ²

Control Screen

Touch - Screen	Yes
Copy Counter	Yes
Memory of the jobs	Yes
Diagnostic and Check	Yes
Setting size, temperature control	Yes
Speed	Yes

Book Loading

Adjustment of the clamp user	Automatic, following the parameters introduced by the user
Clamp opening	Automatic, electrically driven
Clamp closing	Adjustable air

Spine preparation

Milling disks	Ø 160 mm
Notching	2
Roughening for spine processing	4
Brush for spine processing and cleaning	1
Excludable mill	Mechanical (with position control)
Milling thickness	0 - 2.3 mm
Chips aspirator	Included in the machine

Glue application system

Tank PUR/Hot-Melt glue	3 Kg sealed
Extrusion system of PUR/Hot-melt	Integrated and sealed
Extrusion head adjustment	Automatic
Side adjustment (used for signatures or wire stapling)	Mechanical (high accuracy)
Glue Stop	Adjustable by Touch-Screen
Cleaning / sealing	Yes

Press:

Press	Electro-pneumatic servo-controlled
Adjustment	Force / pressure, pressing time

Mechanical Adjustment

Automatic/mechanical height adjustment

Mechanical Adjustment

Cover back bar adjustment

Automatic, driven by the parameters on the

Touch-Screen Cover loading

Hand made by the operator

Dimensions / Weight

Length	1850 mm
Width	1090 mm
Height	1370 mm
Weight	500 Kg



2.1.1 ELECTRICAL

Electrical power 400 V ±5%, 50 Hz, 3 ph + N + PE

Power of the machine	Protection fuses on the power network are duties of the customer
Distribution cabinet, customer side	16 A Differential protection class A 300mA

2.1.2 PNEUMATICS

<p>Supply pressure The pneumatic system of the user must ensure, in the inlet connection of the compressed air in the perfect binder, the following values: Min.: 7 bar air consumption: 200 l/h air quality: Class 3</p>
<p>Pneumatic Characteristics of the machine</p> <p>Compressed air consumption 200 l/h</p> <p>Calibration of input gauge 6 bar</p> <p>Min. working pressure 5.5 bar. If the pressure value falls below this value the machine enter in an “alarm” condition</p> <p>Diameter of air inlet 10mm The 10 mm diameter pipe for the connection to the compressor is not provided together with the machine. It is suggested the use of a compressor equipped with the automatic condensate drain, to avoid verify weekly if there is some water inside the compressor. It is suggested to use a silenced compressor, if the compressor is located inside the working plant.</p>

	<p>Air quality provided to the Perfect Binder CLASS 3, DIN ISO 8573-1 Durst: 5 micron - 5 mg/m³ Water: -20° C - 0,88 g/m³ Oil: 1 mg/m³</p>
	<p>The compressed air system upstream of the machine must be equipped with a dryer.</p> <p>Periodically check the quality of the compressed air supplied to the machine and the operating values .</p>

AIR QUALITY PROVIDED TO THE PERFECT BINDER

To make work the pneumatic devices in an affordable, efficient and safe way, the compressed air supplied to the pneumatic device must have the following quality features: Pressure, Quantity, Water content, solids content, oil content.

DIN ISO 8573-1 - AIR QUALITY CLASS

The manufacturers of pneumatic components refer to the quality of compressed air to use on their products, referring to the table below.

Classe	Corpi solidi		Contenuto d'acqua	Contenuto d'olio
	Max. dimensioni delle particelle [µm]	Max. densità delle particelle [mg/m ³]	Max. punto di rugiada [°C]	Max. concentrazione olio [mg/m ³]
1	0,1	0,1	-70	0,01
2	1	1	-40	0,1
3	5	5	-20	1
4	15	8	3	5
5	40	10	7	25
6	-	-	10	-
7	-	-	non specificato	-

The compressed air used in the industry contains water, oil, dust and other impurities. The interaction of these elements produces an aggressive mixture that can damage the compressed air devices and also the PUR glue contained in the PUR tank, the results will be a low quality production and increased maintenance costs.

3 ACCESSORIES

The standard composition includes:

- Cleaning Kit
- Start- up Kit



CLEANING KIT



<p>Polizene green spatula (to remove excess glue or cleaner)</p> <p>Steel Wire 0.4" (for cleaning the channels of leakage of the lateral glue)</p> <p>Lamella thickness of 0.4 (for cleaning the slit of leakage of the spine glue)</p> <p>Spare Headless screws for the closure of the ducts</p> <p>Protective gloves</p> <p>Set of L wrenches</p>	
---	---

START-UP KIT

<p>One pack of 2 kg of PUR Glue Henkel</p> <p>One pack of 2 liters of beans Cleaner-Blue Henkel</p>	
---	--

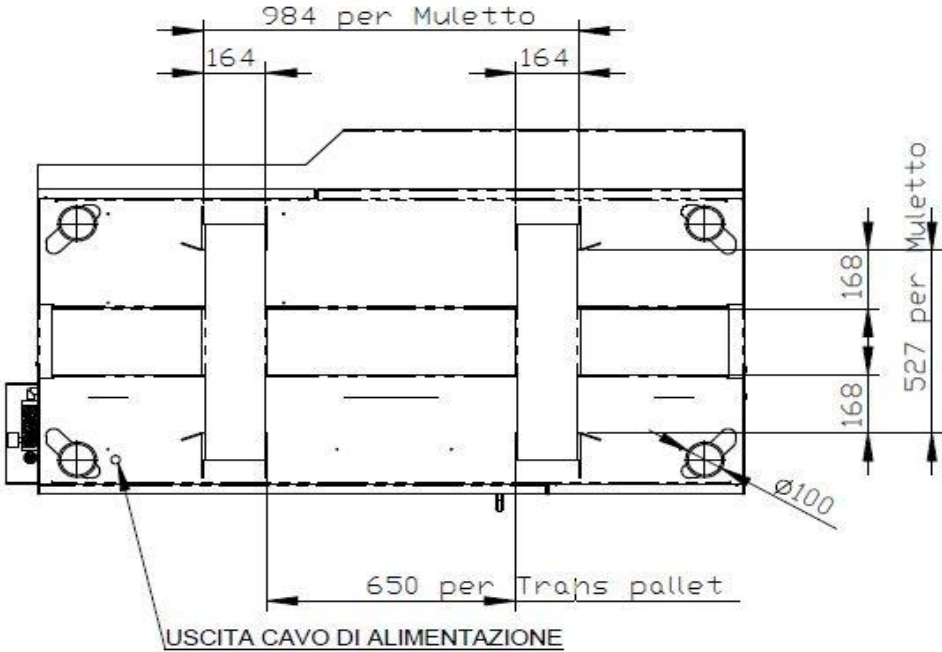
4 TRANSPORTATION

	<p>The Perfect Binder must be handled by a heaver. It can be got on all 4 sides, at the bottom of the frame are provided channels for the insertion of the forks.</p>
	<p>For the final positioning or small movements can be used a trans-pallet. The machine can be raised by trans-pallet only in the 2 long sides, front and rear."</p>
 <p>984 per Muletto</p> <p>164</p> <p>164</p> <p>168</p> <p>168</p> <p>527 per Muletto</p> <p>650 per Trans pallet</p> <p>Ø100</p> <p>USCITA CAVO DI ALIMENTAZIONE</p>	
<p>The image shows the location and size of the channels for the brackets for the trans-pallet and the forklift.</p>	

	DANGER! For no reason the staff is authorized to pass under a suspended load during transport or in the proximity of. The producer is not responsible for what happens during this operation, to be carried out by qualified and authorized personnel, with the necessary individual safety protections (Suit, shoes, gloves, helmet, and glasses).
	Attention! <i>The machine is balanced.</i> In any case keep the forks low. In case of unbalance use weights. It is forbidden to hold by the hands the projecting parts. The machine and its parts must be protected from the weather outside. In particular, water, dust and moisture can oxidize certain elements of the machine, damaging them irreversibly. Follow the usual precautions to avoid falls and bumps.

IMPORTANT

- a) We do not provide tools for docking and lifting.
- b) The disposal of packaging materials will be provided by the recipient and must be conducted in accordance with the local regulations.
- c) Remove dust and dirt accumulated during the transportation.

5 STORAGE

The information contained in this section must be observed in case of temporary storage of the machine that may occur in the following situations:

Installation of the machine not immediately after its delivery.

Uninstalling the machine.

Storage awaiting a new location.

The machine must be stored and transported under conditions of SAFETY as shown in the table below.

<i>Conditions of transportation and storage</i>	
Temperature average	-5/+55° C
Humidity average	30/90%
Lighting	Adequate natural and / or artificial
Weather	Adequate weather protection
Space required	Adequate to allow the operations of lifting and carrying in SAFETY.
Horizontal ground plane	Horizontal ground plane must have a capacity in excess of the total mass of the machine.
In the case of removal or unused for long periods (over 30 days), it is necessary to drain the glue system and to put inside the protection cleaner.	The damage caused by this failure will void the warranty of the glue device.
During periods of downtime you should not open the tank containing the glue; otherwise it accelerates the deterioration creating serious permanent damage to the glue device.	The damage caused by this failure will void the warranty of the glue device.
Protect with anti-corrosive products the parts subject to wear and work plans. Ref. to the section "maintenance".	
Do not climb or place any objects on top of the machine	

6 LAYOUT

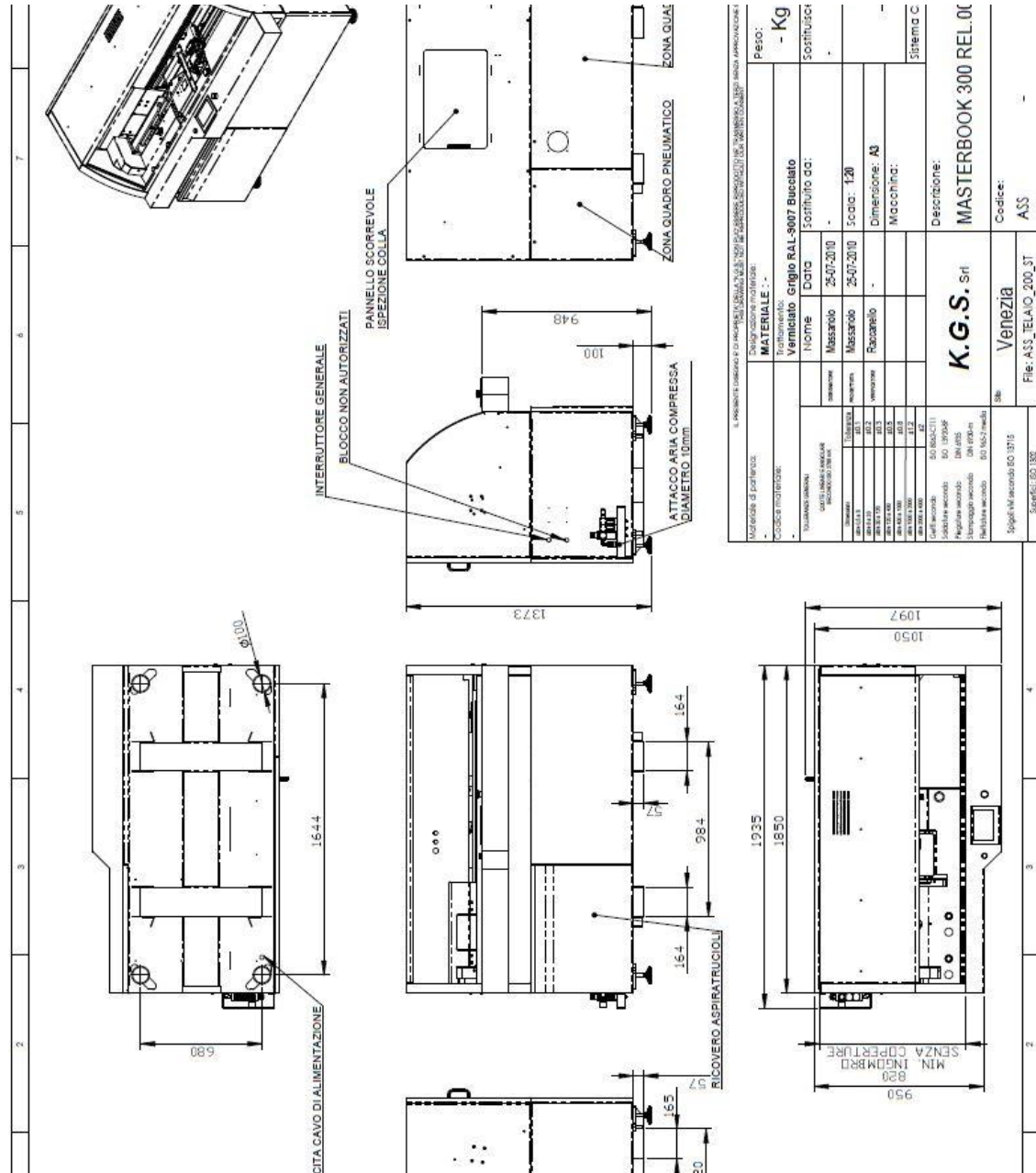

MATERIALE		- Kg	
Sostituisce		-	
Trattamento: Verniciato grigio RAL-9007 buccellato			
Nome	DATA	Sostituito da:	
Massarolo	25-07-2010	-	
Massarolo	25-07-2010	Scalo: 120	
Rabazzolo	-	Dimensione: A3	
Macchina:		-	
Sistema C		-	
Descrizione: MASTERBOOK 300 REL.01			
K.G.S. Srl		Codice: ASS	
Venezia		File: ASS_TELAIO_200_ST	
Spare: 03138E		-	

7 POSITIONING AND WORKSPACES

Positioning:

The Perfect Binder must be positioned so as to have a clear space around of at least 80 cm, and around the work area at least 150 cm.

The room where the machine is installed must be properly ventilated with air change.

8 INSTALLATION

8.1 TECHNICAL STAFF FOR THE INSTALLATION

The machine must be installed by people specifically trained and authorized by K.G.S. .

8.2 PHYSICAL CHARACTERISTICS OF THE AREA OF PLACEMENT

In addition to the overall dimensions of the machine given in the previous chapter, you must also meet the following conditions:

Near the area of placement of the machine should be arranged the sources of electric power and pneumatic following what is written in this manual.

Provide sufficient space for normal use, maintenance of machinery, for any command and for additional equipments to connect. Refer to the draft in the chapter of the positioning.

The chosen site should not be close to deposits of flammable materials, or to operational sites that may create flammable or explosive atmospheres.

For the installation you must choose an operational area depending on the size of the machine parts and lifting equipment selected, pay attention to the presence of any obstacles on the road (equipments, walls, etc.).

8.3 SUPPORT SURFACE

The machine requires no special foundations. It must be ensured the availability of an industrial floor.

The producer has no responsibility about the enforcement of foundations (resistance calculation, thick reinforced concrete, etc.), which are under responsibility of the customer or company performing the design and construction of the foundations themselves.

The Perfect Binder rests on four feet of 100 mm diameter.

8.4 WEATHER PROTECTION

The machine must be placed in a covered room, protected from direct contact with atmospheric agents.

8.5 LIGHT

To use and maintain in a safety way the machine a good light is needed. The room lighting should have a value that should allow normal operations without causing risks to the shadows.

8.6 ENVIRONMENTAL CONDITIONS



The values of temperature and humidity should be within the values in the table below. In case of use of the system in corrosive environments it is important to intervene in the maintenance of the machine with adequate time to avoid excessive wear of components.

	MIN	MAX
Room temperature	5 ° C	40 ° C
Relative humidity	20%	80%

8.7 ELECTRICAL CONNECTION

Electrical cable

The end of the cable is prepared according to the destination of the Perfect Binder.

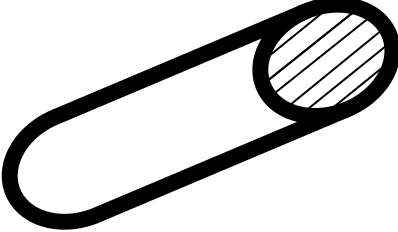
		<p>a) With the European standard plug with protective earth (PE) mounted on a 3 meters length cable</p>
		<p>b) Cable length of 3 meters with sectioned end, with the earth conductor (PE) It is the responsibility of the user to adjust the connection cable in accordance with the applicable legislation.</p>

8.7.1 GROUND CONNECTION

The Perfect Binder is equipped with an earth conductor (PE).

	<p>During the installation the customer must realize the ground connection in accordance with the applicable legislation.</p>
---	---

9 TRAINING OF THE OPERATOR



DANGER! The operator must be trained about the operations to perform during the occurrence of possible faults, malfunctions or conditions of danger to themselves or others, and anyway he must perform the following procedures:

Stop the machine quickly by pressing the emergency button (red button installed aboard of the machine herself);

Do not carry out operations that go beyond the specific knowledge and techniques;

Immediately inform their superior head, avoiding taking personal initiatives.

It is assumed that the operating and maintenance personnel possess the following minimum requirements:

- Culture in general and specific enough, each to his ability, to read and understand the contents of the manual including the correct interpretation of drawings and diagrams, pneumatic and hydraulic;
- Ability to understand correctly the symbols and video messages;
- Overall knowledge of the machine and the plant in which it is installed;
- Specific experience in the applied technology;
- Knowledge on what to do in an emergency, the availability of personal protection equipment and how to use them.

10 POWER ON

- 1) Be sure that the machine is correctly fed by air.
- 2) Turn on the machine turning the general switch.
- 3) Open the valve on the premelter
- 4) Close the rear inspection panel.

On display you will see:

- machine in emergency
- machine with cleaner
- machine not in temperature

The red light is on

- 5) Press once the green key,

Green is blinking

Orange is on

Red is blinking







On display:



Machine with cleaner

Low temperature



- 6) Exit from the alarms page using the arrow, in case the machine is equipped with the table to measure thickness, you must press "OK" to set to zero the table.
- 7) When the temperature icon becomes green, press the green key. The machine sets to zero the axes.
- 8) Press the key "glue cleaner" to load the glue.
- 9) Set values for the book you are going to manufacture and press the green key.
Orange light is on, the green one is blinking
- 10) Put the book in the clamp, position the cover and press the green key.
Once the book is completed, remove carefully the book and position a new cover and a book block. The machine will start again as soon as it will have:
 - The book in the clamp
 - The cover in the nipping station
 - Safety photocells free

10.1 FUNDAMENTALS

	<p>Pay Attention during the glue loading because of the high temperature, as indicated by the label, and use protective systems such as gloves.</p>	
	<p>Never open the tank when it is cold.</p>	<p>The moisture in the air would enter the tank and remain trapped, causing premature aging (curing) of the PUR glue and producing blockages and maintenance need.</p>
	<p>The machine can't stay with the glue tank opened more than 10 minutes if there is PUR glue inside.</p>	<p>The glue in contact with moist air modifies her composition, creating damages to the machine.</p>
	<p>The machine can't stay with the glue system empty for more than 2 minutes</p>	<p>The PUR glue dries permanently; in this case you risk permanent damage to the glue system. If you don't have a glue cartridge available, put in the tank at least 500 grams of Blue and wait to be melted before to switch off the machine.</p>
	<p>The tank has to be added with the same type and model of glue. You can use a different kind of glue only when the system is completely empty and cleaned by using the Blue-Cleaner.</p>	<p>Drain as much as possible the glue that you want to replace. Enter in the tank a quantity of about 600g of Blue-Cleaner and make it protrude from the main slot and the channel of the glue; if at the end of this cleaning cycle you are not sure that from the valve 100% Blue-Cleaner exits, repeat the operation.</p>
	<p>Avoid opening the lid frequently, the moisture in the air damages the features and durability of the glue.</p>	

	<p>The depletion of the glue is found in two ways: the lack of glue on the book; issuing at the extrusion zone glue clear glue mixed with air vents and glue bubbles.</p>	
	<p>When you finish the glue and insert a new cartridge you have to wait about 10 min before the new glue melts.</p>	
	<p>The machine is not operational until the set temperature is reached.</p>	
<p>Red light on</p>	<p>Machine in emergency with auxiliary turned off</p>	
<p>Red light blinking</p>	<p>Machine on cycle with warnings</p>	
<p>Red light off</p>	<p>Machine in emergency and without alarms on</p>	
<p>Orange light on</p>	<p>Machine with fed auxiliary</p>	
<p>Orange light blinking</p>	<p>Auxiliaries turned on or off in</p>	
<p>Orange light off</p>	<p>Auxiliaries turned off</p>	
<p>Green light on</p>	<p>Machine on cycle</p>	
<p>Green light blinking</p>	<p>Machine not on cycle</p>	
<p>Green light off</p>	<p>Machine not ready</p>	

10.2 ELECTRICAL CONNECTION

		<p>Make sure that the cable of the Perfect Binder is connected to electricity network with the specified features.</p> <p>Turn on the main switch located on the left side of the machine, turn right to achieve the position 1= (ON).</p>
---	---	--

10.3 PNEUMATIC CONNECTION

Connect the pneumatics performing the following procedure:



	<p>Connect the pipe (10mm external diameter) to the quick of the Perfect Binder.</p>
---	--

	<p>Danger! Risk of collision due to uncontrolled movements of the pipes subjected to passage of compressed air.</p>
---	--

10.4 DESCRIPTION OF THE GROUPS

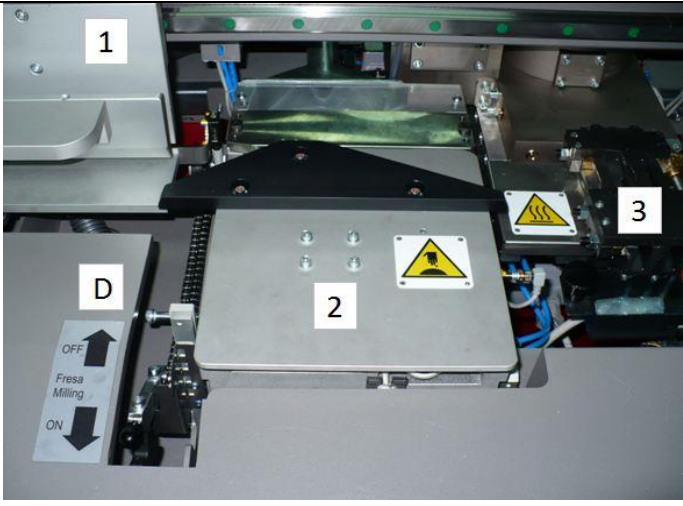
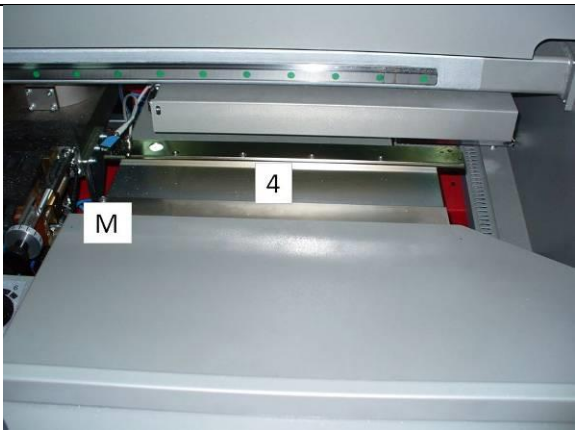
	<p>Position OFF</p> <p>Main switch open. The machine is off.</p>	
	<p>Position ON</p> <p>Main switch closed. The machine is on.</p>	
	<p>1) CLAMP</p> <p>2) MILLING STATION</p>	
	<p>A Glue pressure regulator</p> <p>Allows to adjust the amount of glue coming out of the extruder.</p> <p>Approximate values</p> <p>Pressure = 0 lack of glue (don't use)</p> <p>Pressure = 1.2 - 1.8 (books up to a 5mm)</p> <p>Pressure = 1.8 - 2 bar (books 5 - 10mm)</p> <p>Pressure = 2 - 3 bar (books 10 - 30mm)</p> <p>Pressure = > 3 bar (books 30 - 50mm)</p>	
	<p>B Press pressure regulator</p>	

	<p>Allows to adjust the press force on the book side Pressure = 0 - 2 bar min. force Pressure = 3 bar med. force Pressure = 5 bar max .force</p> <p>C Milling height regulator</p> <p>Allows to adjust the milling (in mm) position = 0 only notching position = 0.5 - 1 the best milling and notching situation position = 2.3 max. milling and notching</p>
	<p>1) CLAMP 2) MILLING STATION 3) GLUE SYSTEM D) Exclusion lever for the Milling Station group Lever in position ON = working Lever in position OFF = off, and lowered.</p>
	<p>4) PRESS M) Cover squaring adjustment</p>

	<p>On the back Gate access to the tanks. The machine moves only with the door closed.</p>
	<p>5) GLUE TANK 6) CLEANER TANK L) Glue pressure tap -- closed open H) Chips aspiring tube</p>

10.5 CHIPS ASPIRATOR

The chips aspirator is located inside the cabinet of the Perfect Binder and is electrically connected to the Perfect Binder herself.

When the Perfect Binder is delivered, the chips aspirator is ready, mechanically (aspiration tube) and electrically connected, he switches on and off together with the Milling Station.

Front picture: chips aspirator (see the arrow)

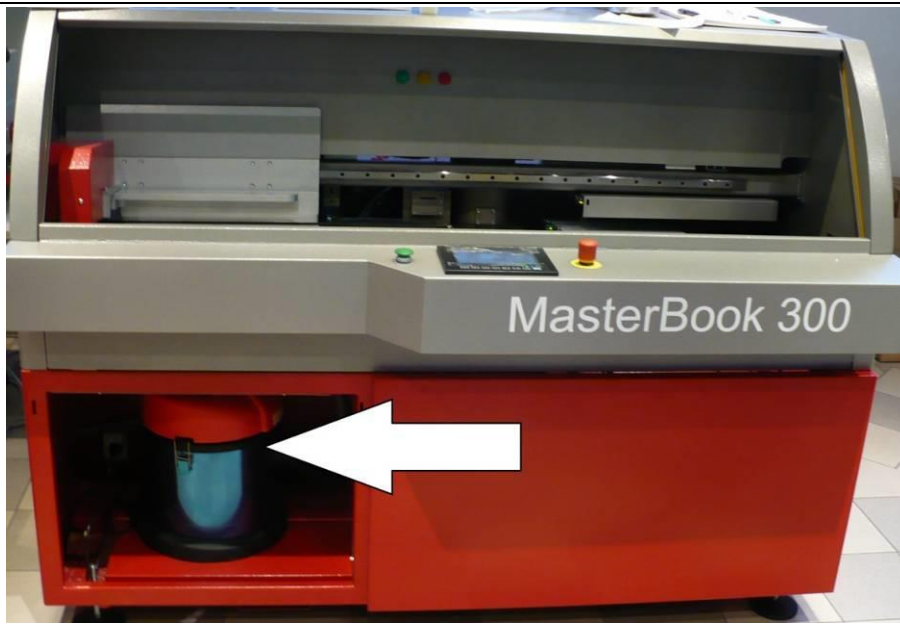

Aspiration tube
In the back of the Perfect Binder, connected to the back preparation station.



Switch
It must be in "on" position (I = ON) during the operation of the Perfect Binder.



Every day the chips aspirator must be emptied and cleaned to be





ever efficient.

10.7 PUR TANK OPENING AND CLOSING, AND GLUE LOADING.

10.7.1 OPENING OF THE PUR TANK

To access the glue tank it is necessary to open the sliding door provided with handle. The opening of this protection put the machine in a state of emergency and reduces the pressure of the glue tank while the Cleaner tank remains at a pressure of 2 Bar. The machine can't work with the back door open.

WARNINGS ON THE OPENESS OF PUR TANK

	Wear hand protection, all parts are at high temperatures.
	Never open the tank while it is COLD. The air moisture would enter and remain trapped in the tank causing premature aging (curing) of the PUR glue with probable clogging and maintenance need.
	Avoid to open the PUR tank with no reason.
	Limit the opening time. Close the tank as soon as possible

Follow carefully the sequence below.

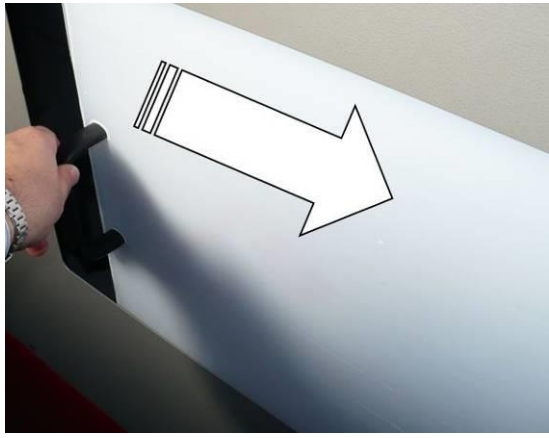
	Open the sliding door in the back of the machine, provided with an handle. The machine goes into a state of emergency and takes away the pressure to the glue tank, while the cleaner tank remains under pressure of 1 bar.
---	--



1) Loosen the lock knob. Turn it counter clockwise.

Attention! High temperature!
Wear protective gloves.

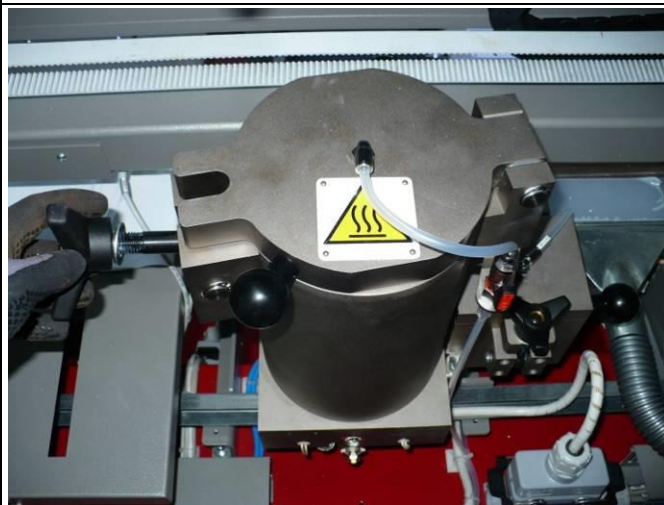



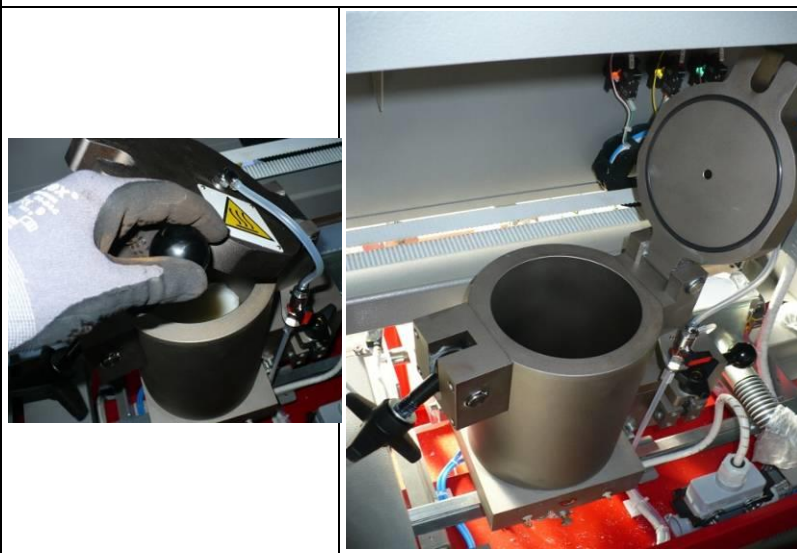

2) Tilt locking knob to its rest position. The cover is so free to open.



3) Lift the lid to its fully open by grasping the lateral knob.

10.7.2 PREPARATION AND LOADING OF THE PUR GLUE

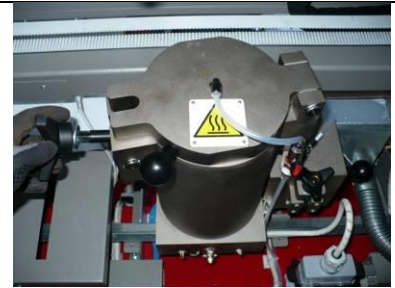
		<p>Take a bottle of glue and verify the integrity of the aluminum color pack, and make sure that the expiration date printed in the package is not over</p>  <p>Please read the SAFETY cards of the used glue, and follow all the instructions of the manufacturer.</p>
		<p>Cut the foil, by using a sharp tool.</p> 
		<p>Remove completely the foil.</p>
		<p>Insert the cartridge into the tank. Attention! High temperature! Use protective gloves.</p>  

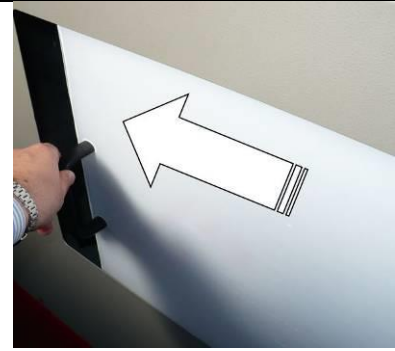
		<p>Close the cover.</p>
		<p>Remove the knob, paying attention to high temperature components. Turn the knob clockwise vigorously to tighten the tank.</p>
		<p>Close the sliding door in the back of the machine, provided with an handle.</p>

10.7.3 CLEANER LOADING

	<p>Open the sliding door in the back of the machine, provided with an handler.</p> <p>Attention! High temperature! Use protective gloves.</p> <div style="text-align: center;">  </div> <p>Read carefully the SAFETY cards of the used cleaner, and follow all the instructions of the manufacturer.</p>	
		<p>By loosening the knob of the cleaner tank you will notice an air leak, this is normal as the machine continues to provide air to the tank.</p>
		<p>Fill the tank with cleaner to about 3 / 4 of its volume by using a small container.</p>
		<p>Replace the cover using the knob on the side and pay attention to the high temperature components.</p> <p>Lift the locking knob.</p>

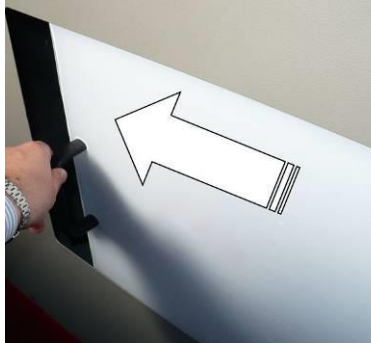
		<p>Tighten the knob until the noise of escaping air disappears.</p>
		<p>Close the sliding door in the back of the machine, provided with a handle.</p>

11FUNCTIONS OF THE PERFECT BINDER

11.1 START UP PAGE



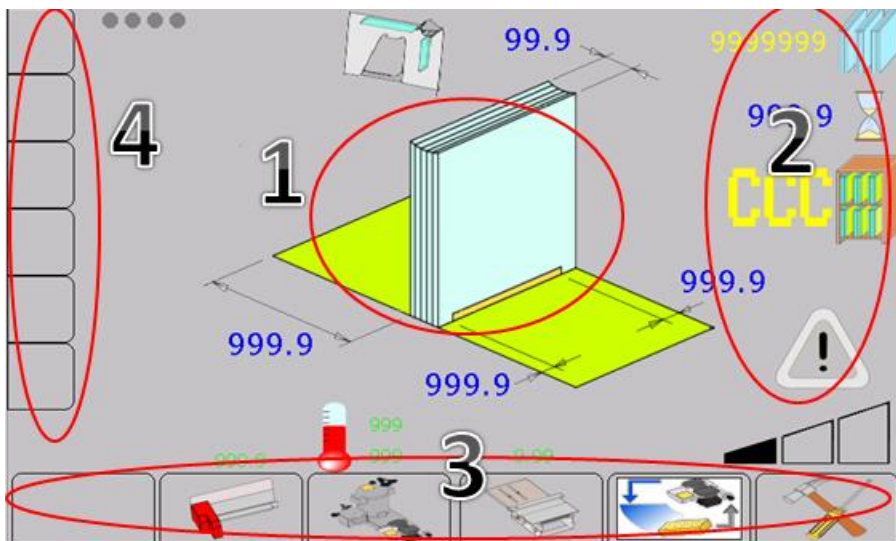

Areas division





Area 1

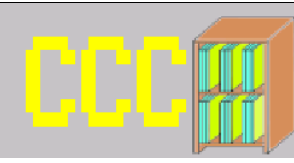
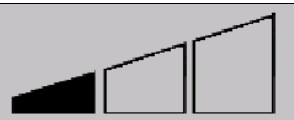

	<ul style="list-style-type: none"> -Selector for the book type -Front glue stop -Rear glue stop -Cover set -Book thickness
	<p>Optional: Thickness detection for the book. Position a book onto the measurement table and press the key, the machine will modify the clamp dimension and also the dimensions of the glue station.</p>

Area 2

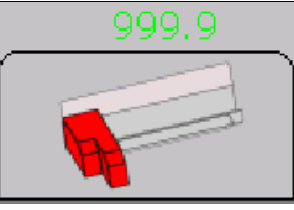
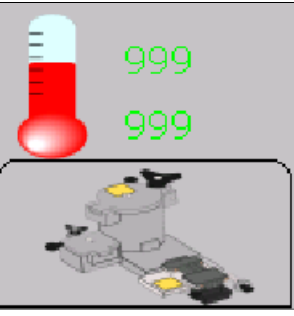

	<p>Meters display</p>
	<p>Selector for permanence time of the book in the clamp.</p>
	<p>Management page for working JOB. Go to page 63</p>
	<p>Speed selector 1-2-3</p>
	<p>Alarms It will blinking red in case there are alarms or warnings.</p>

Area 3

	<p>Clamp set up</p>
	<p>Glue station set up See page 54</p>
	<p>Nipping station set up</p>

	<p>Cleaning procedure with CLEANER or GLUE loading</p>
	<p>Advanced set up</p>

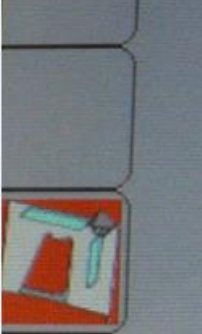
Area 4

	<p>Groups status bar If red, turned off If yellow, value modified in the advanced set up</p>
	<p>Status bar. 1 book in the clamp 2 milling station 3 glue station 4 cover</p>

11.1.1 DISPLAY FOR PRODUCTION METERS



	<p><i>Meter of total production</i> Meter showing items produced during the life of the machine. It is not possible to reset it.</p>
	<p><i>Meter of partial production</i> Meter showing the items produced by the machine. It is possible to reset it with the Reset key.</p>
	<p><i>Meter of produced items</i> Meter showing the items produced during the current day. It is possible to reset it with the Reset key.</p>
	<p><i>Items to be produced</i> Meter showing the items to be produced. Press the blue key and enter the desired quantity.</p>

12ALARMS PAGE

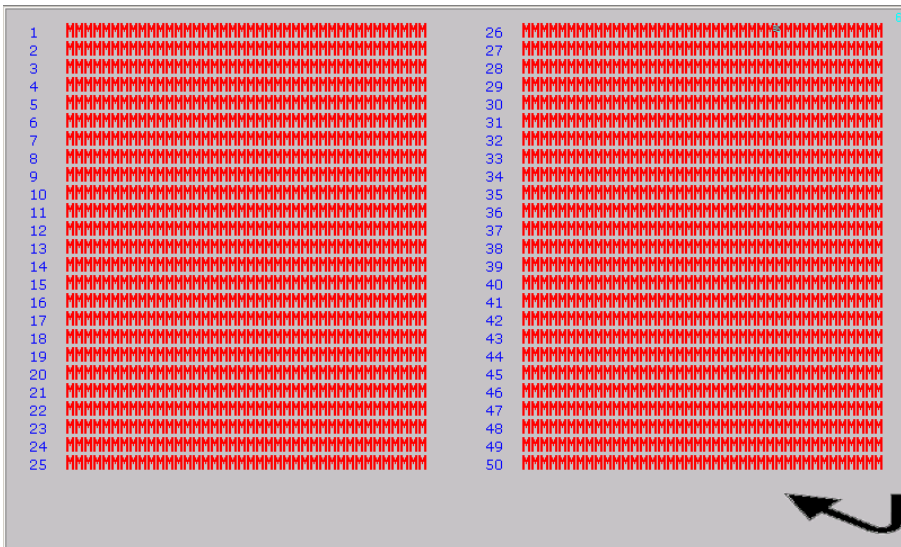





List of Warnings and Messages :

Warnings	Description
Air pressure fault	Air pressure fault to the machine. Check valve or current pressure that supplies the line.
Auxiliary fault	Auxiliary fault. Verify that the emergency button is not pressed or that the SAFETY barriers are not engaged with the machine on cycle or in movement.
Drive milling station error	Driving error for Milling Station engine control.
Drive nipping station error	Driving error for Nipping station engine control.
Drive carriage error	Driving error for carriage engine control.
Rear glue panel open	Rear panel for loading/inspecting glue tank open.
Glue station not ready	Glue station (premelter and head) not ready to move. In this case it is not possible to perform any function that directly depends on head movement.

Book in the nipping station	It requires to start a cycle with a book in the nipping station. If there is no book, verify if the cover is perfectly aligned to the nipping station and does not accidentally shroud the sensor for book presence.
Cover not present	It requires to start a cycle, but there is no cover on the nipping station.
Verify book in the clamp	It requires to start a cycle but there is no book pack the clamp.
Inability to perform PRESET. Head temperature not reached	It is not possible to position the machine because the glue station is not ready. Wait for heating.
Glue head not in position	The glue head is in a lower position compared to that one set to allow the passage of the book.
Set to ZERO!!	It requires a set to ZERO
Head in standby	The head is locked in a manual standby.
Active cleaning cycle for the head	Active cleaning cycle for the head
Set up for the axis	Request for positioning the machine in order to start the cycle
Milling station off, set the jogger to ZERO	The lever for excluding the milling disk was lowered, it is necessary to lower the grip trimmer to the ZERO position.
Milling station not in position	The lever for excluding the milling disk is not in an acceptable position UP or DOWN.
Cleaner into head, load glue	At shutdown of the machine the head cleaning has been made with the automatic cycle of the cleaner. Eject the cleaner and load the glue.

13 PARAMETERS FOR SINGLE AXES (GROUPS)

Standard symbols that you will find in the following pages.

	Access to manual movement page
	Axes reset
	Group movement in the direction indicated by the green arrow. If you push the green arrow, the dimension increases.
	Group movement in the direction indicated by the red arrow. If you push the red arrow, the dimension decreases.
99.9	The value in blue can be modified by the operator. The value in green can be modified by the operator

13.1 PARAMETERS FOR NIPPING STATION/CARRIAGE

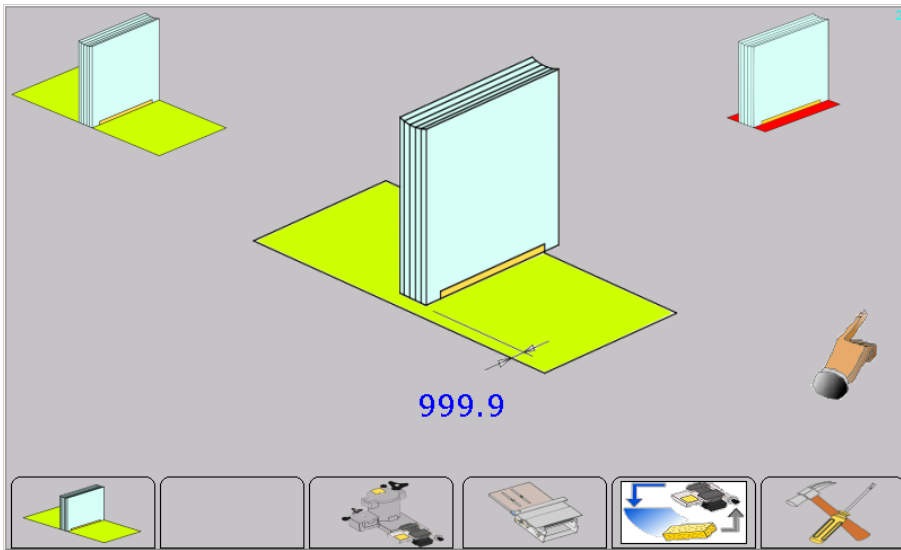

Offset for carriage position	+ 5mm - 5mm	Offset for the arrival position of the carriage onto the nipping station. This allows to position the book rightmost (positive value) or more left (negative value) compared to cover. Entering zero value (0) the book will be aligned to the cover.
------------------------------	----------------	---

Manual movements for the nipping station

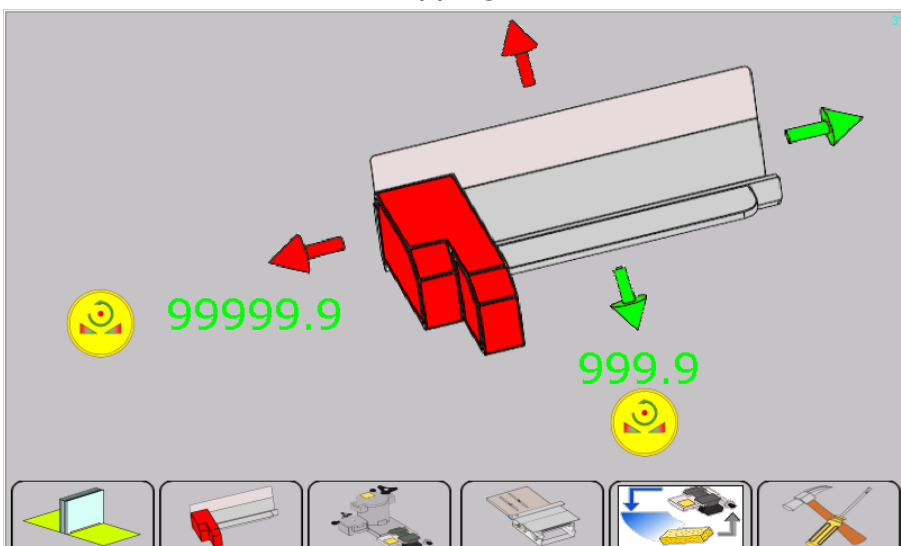

13.2 PARAMETERS FOR THE HEAD OF THE GLUE STATION

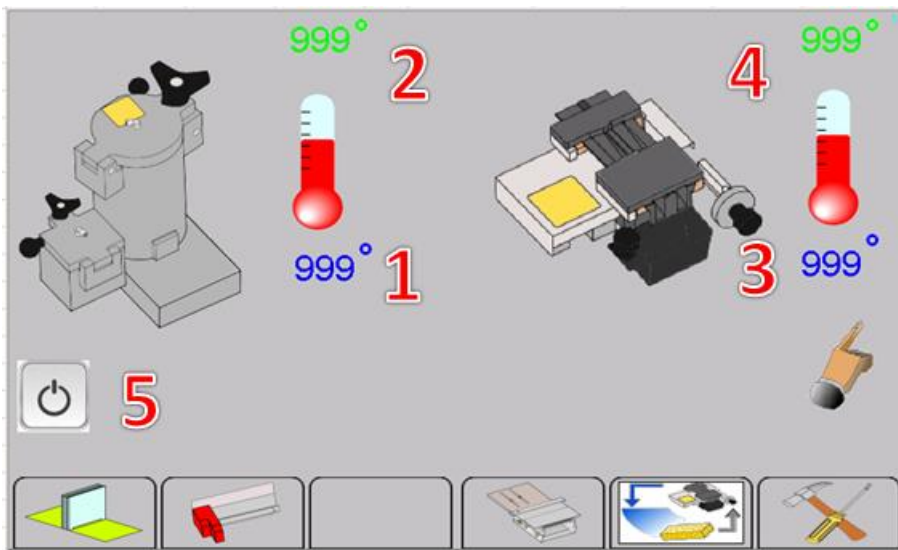

Management for working parameters of glue station head

1	Temperature control for pre-melter
2	Current temperature for pre-melter
3	Temperature control for the glue head
4	Current temperature for glue head
5	Stand by

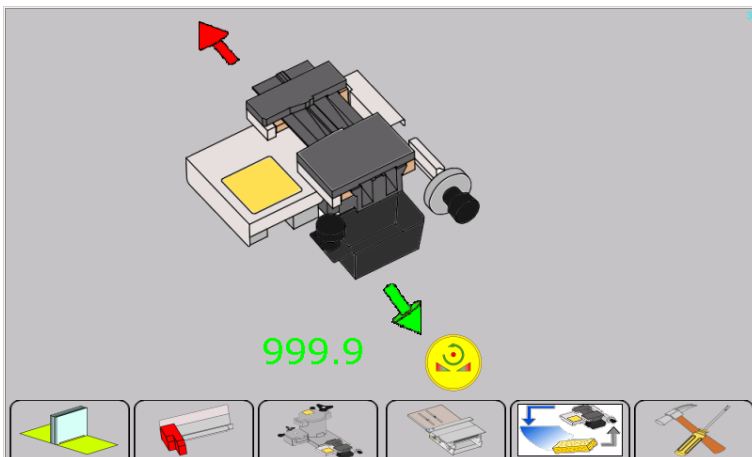

The temperature must be set on the basis of the glue type you are going to use. Refer to temperatures suggested by glue producer.

The pre-melter temperature must be kept from 5° to 15 ° less than that the extrusion temperature.

During the heating, the indicators will be red and the machine will show the message

“Glue station not ready”.

When the detected temperatures correspond to the fixed temperatures, the indicators will be green.

So the machine will start to move the glue station while it waits for stabilizing the temperatures. At the end of this process the machine will be ready to start.

The standby status will decrease the temperatures of 30°

If the machine does not produce any book for more than 30 minutes, the machine automatically goes into standby

- The head for the extrusion is closed
- The temperatures decrease of 30° in order to protect the glue from unnecessary prolonged heating.

To go back to normal condition press the display. After that, you have to wait for glue station to reach the fixed temperature.

When the temperature is correct, it will be possible to position the axes and proceed with book production.

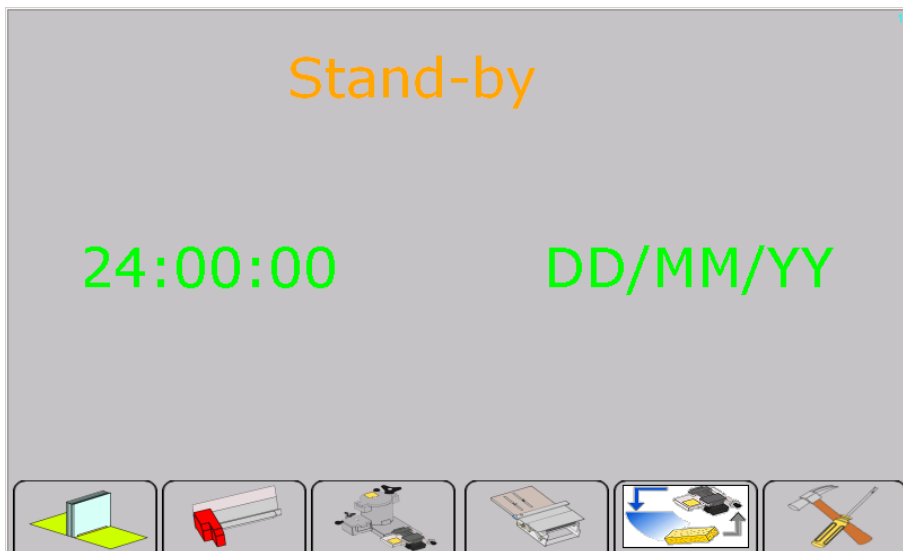

13.3 PARAMETERS FOR NIPPING STATION

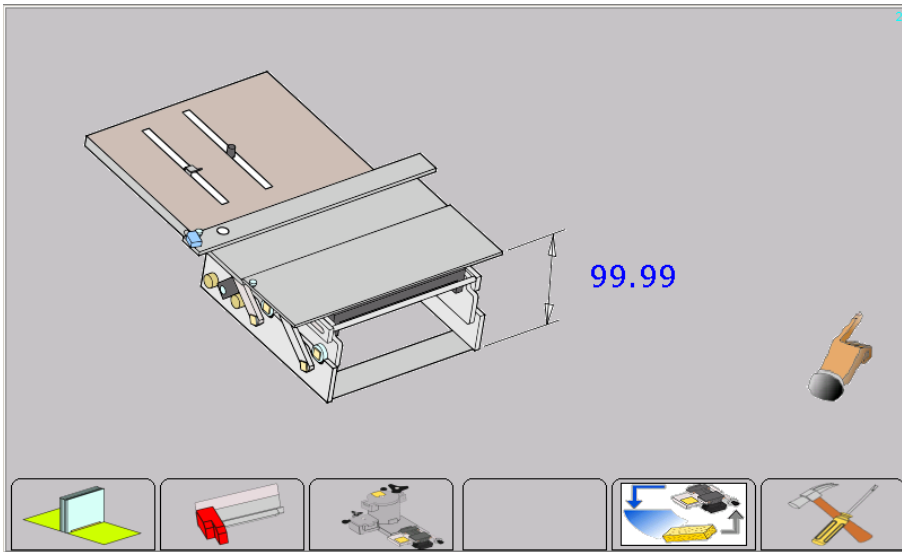

Management of working parameters for nipping station

Nipping station height	From 0mm to 1.8mm	Tune the distance of the spine plate to the book.
------------------------	-------------------	---

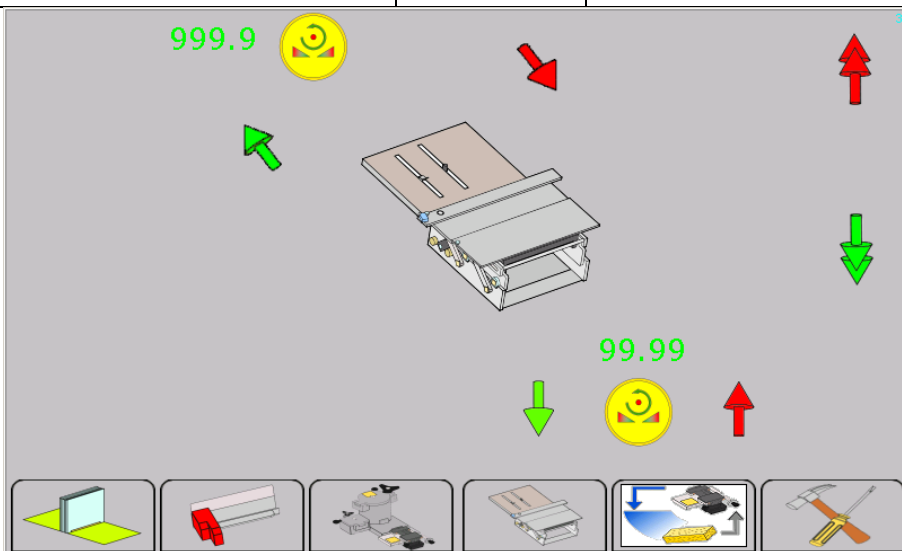

13.4 CLEANER AND GLUE LOADING

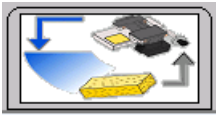

See chapter 19 and 21.

14. ACCES TO ADVANCED SET UP PAGES

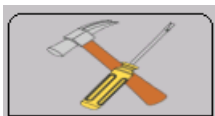

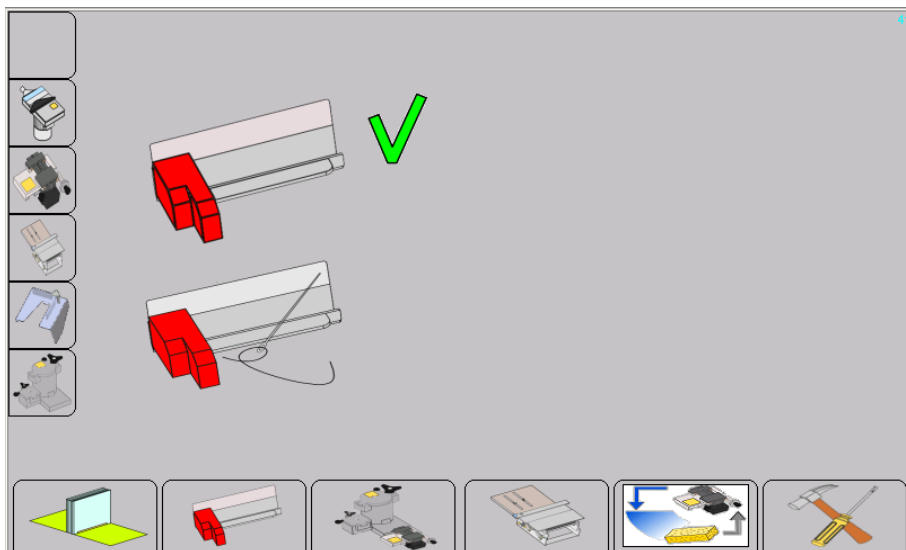

14.1 NIPPING STATION SET UP

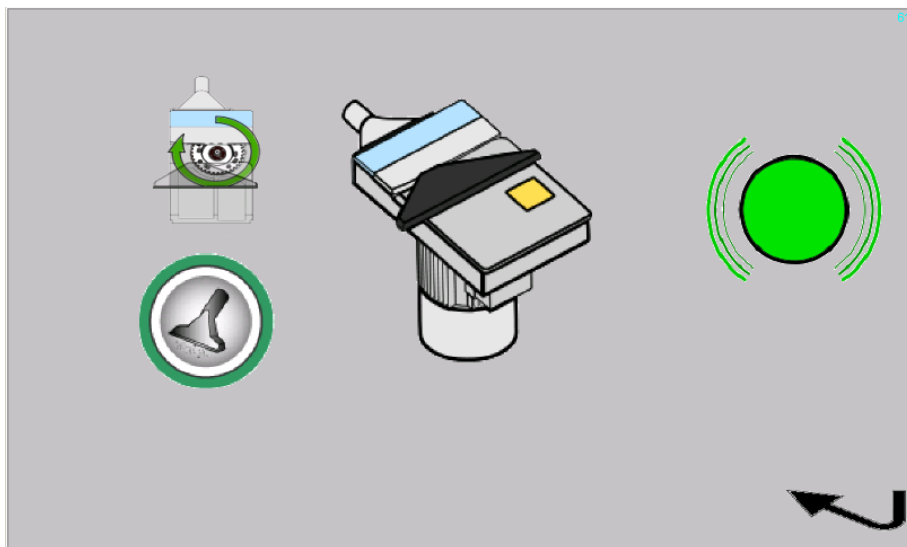

		<p>Nipping station with a standard set up</p>
		<p>Nipping station with a set up for a sewing book, it widens more when you position the book.</p>

14.2 MILLING STATION SET UP



		<p>Power vacuum cleaner</p>
		<p>Release of the engine braking on the nipping station, it only works when the emergency button is pressed.</p>

14.3 GLUE HEAD SET UP

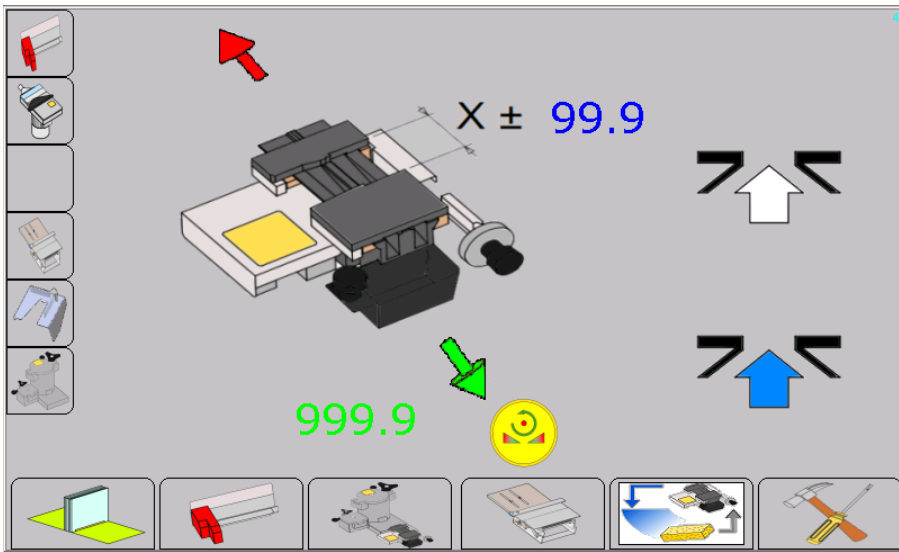

Manual operation for glue station:

		<p>Glue spillage Doing one push, you move the pins. Hold the key, it spills the glue.</p>
		<p>With this key it is possible to activate cleaner spillage.</p>
		<p>Offset compared to the default value.</p>

14.4 NIPPING STATION SET UP

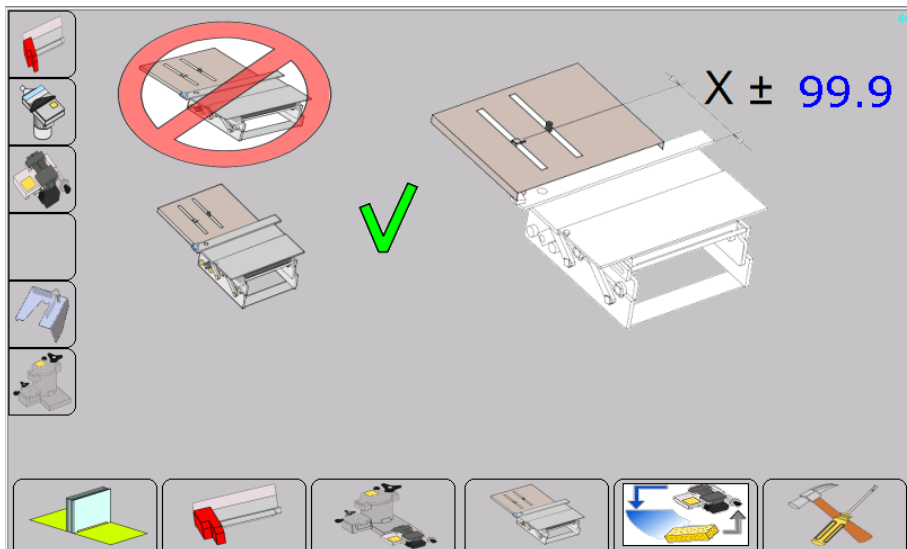

		Nipping station not active
		Nipping station active
		Offset compared to the default value.

15MANAGEMENT PAGE FOR WORKING JOB

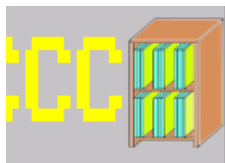

15.1 MANAGEMENT OF THE JOBS

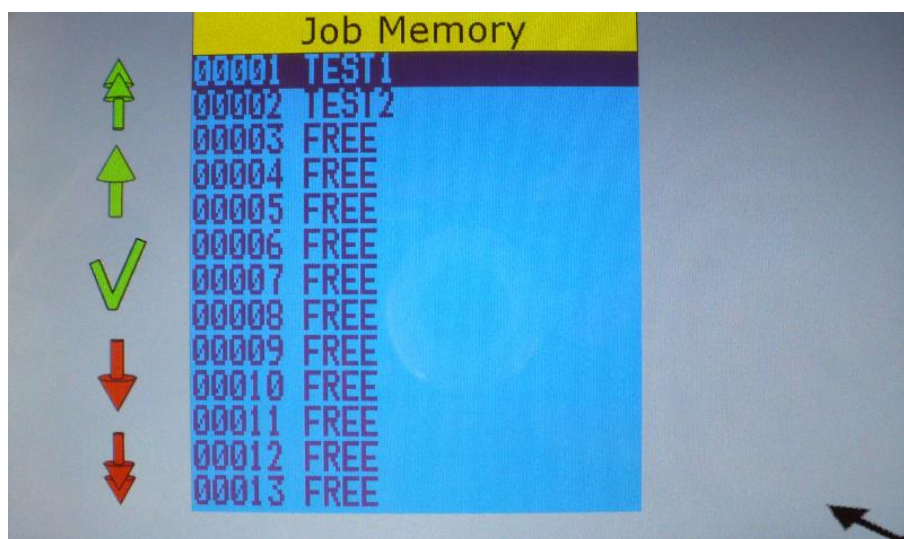

Job Memory	
00001	TEST 1
00002	TEST 2
00003	FREE
00004	FREE
00005	FREE
00006	FREE
00007	FREE
00008	FREE
00009	FREE
00010	FREE
00011	FREE
00012	FREE
00013	FREE

It is possible to save until 100 working JOBS.

Using the green and red arrows pick a free page and hold the key “SALVA DATI” to save the set up you have used to manufacture the current product. In addition to that it is possible to complete the JOB adding all the information you need inside the green boxes. After you have completed the green boxes, save the JOB.

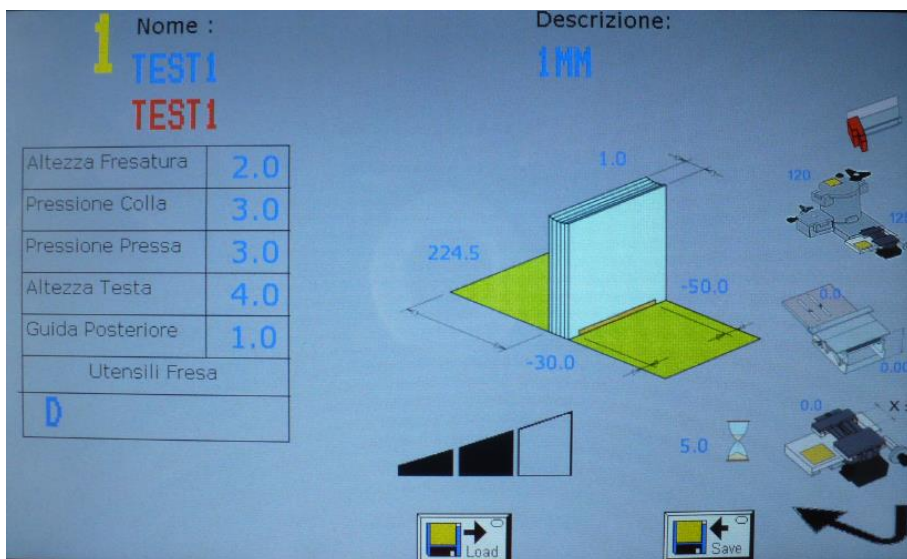

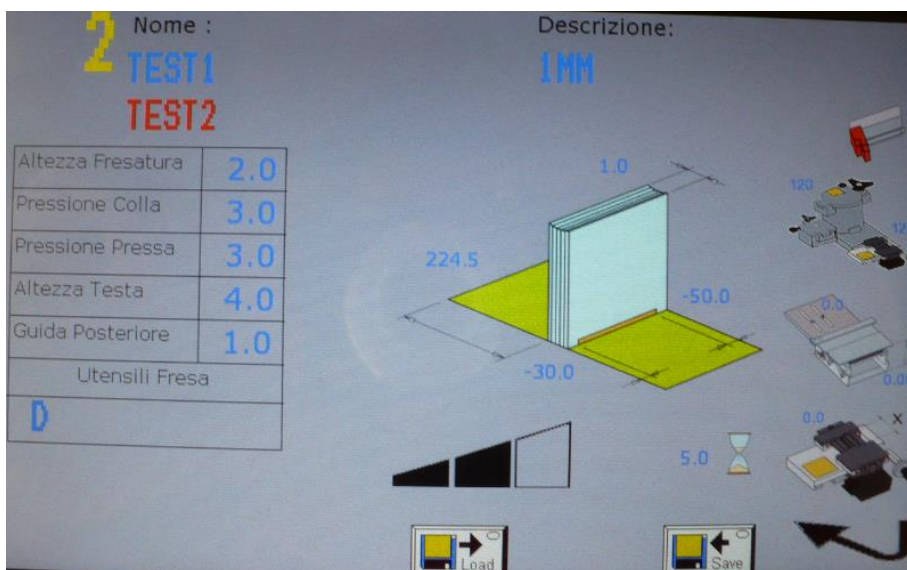

Using the arrows UP and DOWN pick the page with the desired JOB and hold the key “CARICA DATI”. The machine will update all the positions of the automatic axes. It is necessary to manually operate for manual settings.



16GLUE RECOVERY PROCEDURE

The glue recovery procedure must be performed every time the machine has been switched off by using the procedure “End of job”.

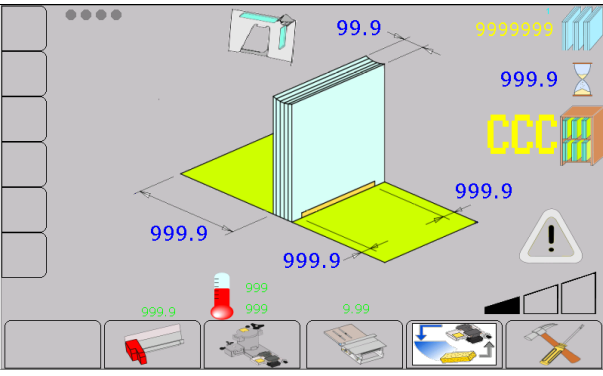
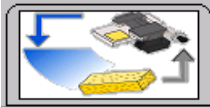
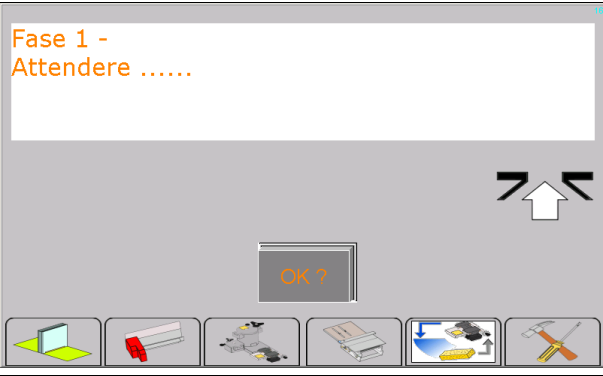
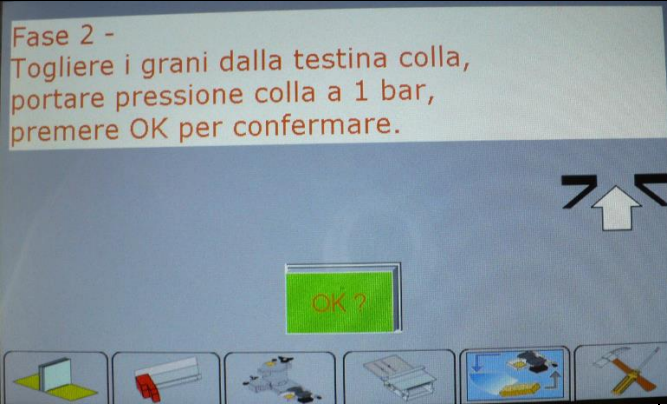
If the machine has been switched off by using the procedure “End of job”, it will be impossible to start again to work without the glue recovery procedure; an error message will be displayed: cleaner error in the glue group.

	<p>Primary condition:</p> <ul style="list-style-type: none"> • machine in temperature • tank valve open, vertically.
	<p>Press and hold the BUTTON  for a few seconds to start the glue recovery process</p>
<p>Fase 1 - Attendere</p> 	<p>The head of the glue group opens.</p>
<p>Fase 2 - Togliere i grani dalla testina colla, portare pressione colla a 1 bar, premere OK per confermare.</p> 	

Remove the headless screws using the L wrench and take the manometer of the glue at pressure 1 bar

Press the button OK

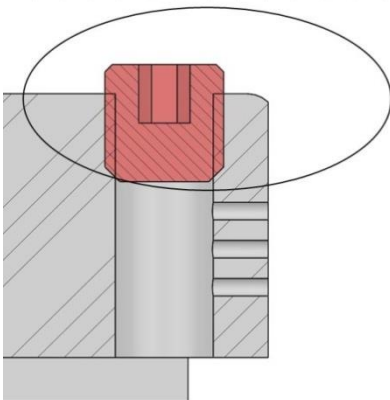
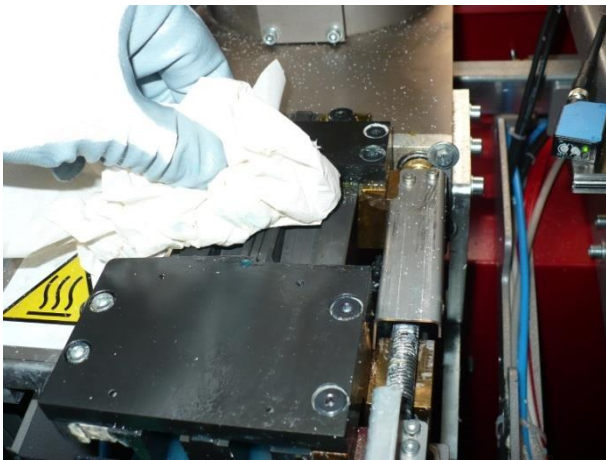
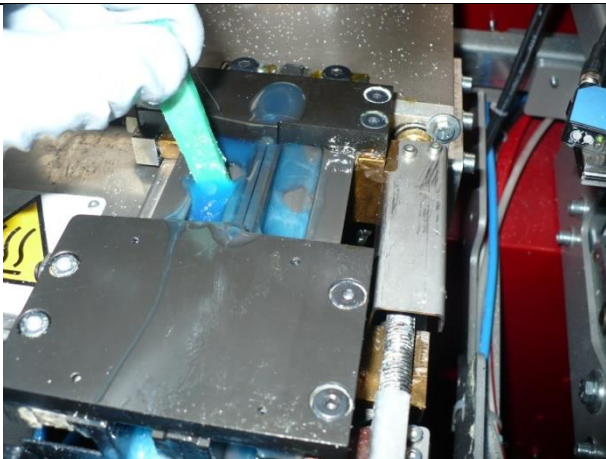
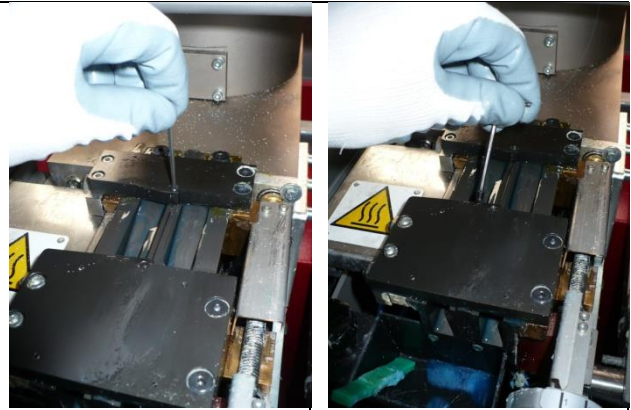

Press the button “ANCORA COLLA” until the traces of Blue cleaner disappear. Help the glue to exit from the bin by using the green spatula.

Clean carefully all the excess spillage using the spatula and paper towels

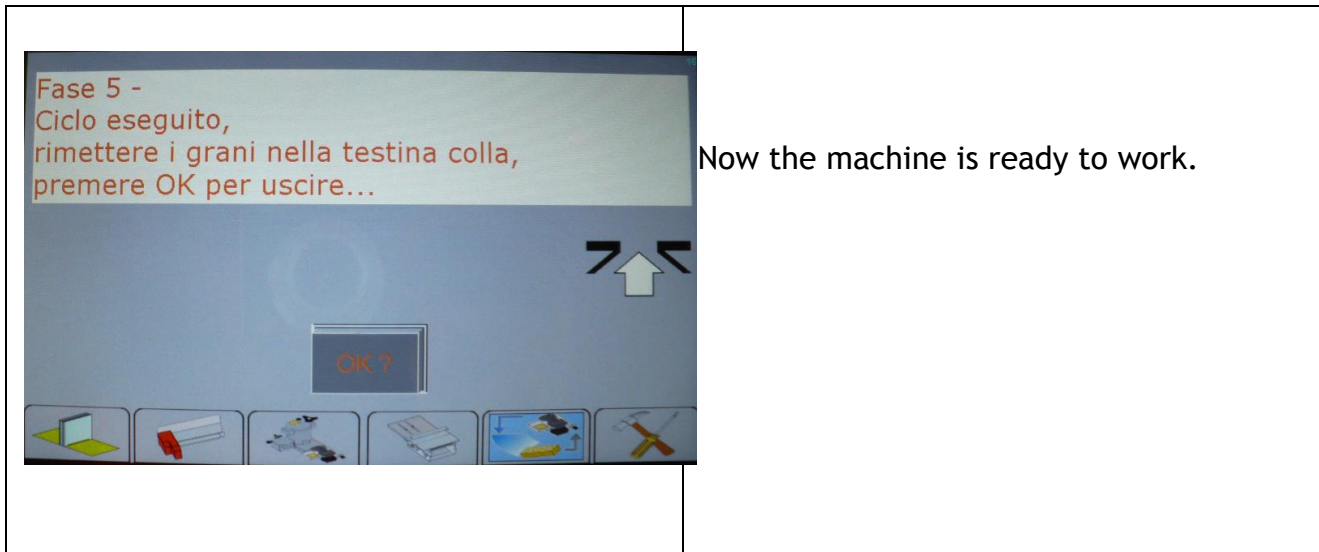

Replace the headless screws using the L-wrench provided (beware of temperature), press **OK**. Attention! Headless screws max. protrude 1 mm



17COVER POSITIONING

	<p>The parameter shows the cover position.</p>
	<p>The value indicates the X dimension.</p>
	<p>Position the cover manually as shown by the arrows.</p>

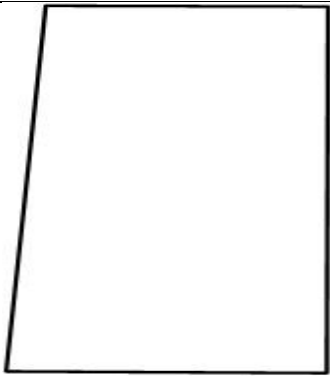
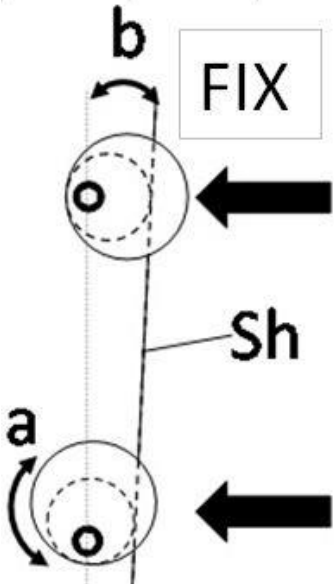



The standard calibration requires that the angle between the sides of the cover is 90°.



	<p>The standard calibration requires that the angle between the sides of the cover is 90°.</p>	
		<p>If the cover has some problems caused by improper trimming, you can adjust the placement by adjusting the position of the eccentric on the operator side.</p>
		

Preparation of the machine to produce a book.

CONTROLS TO PERFORM BEFORE STARTING THE JOB

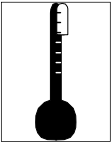
Before to use the Perfect Binder perform the following controls:

	The operator must have read and understood this manual, including the important information concerning the SAFETY.
	Make sure you have appropriate clothing to work and, if necessary, also safety clothing.
	Ensure that the Perfect Binder is properly powered and connected to ground (PE)
	Ensure that the pneumatic system of the Perfect Binder is properly fed and if the main switch oh the factory is open.
	Verify that the chips aspirator is connected to the Perfect Binder and its power switch is in position 1 = ON.
	Check that in the tank there is a minimal amount of glue to allow to process several books, otherwise insert a new cartridge of glue inside the tank.
	Glue collection tank flushed.
	Ensure that the Perfect Binder is clean and without books or covers, especially: Clamp, Silent Plate, Milling Station, PUR head, Press.
	Check that the temperature settings are correct for the used glue and that have been achieved the correct values to work. Refer to the technical sheets of the glue/cleaner manufacturer.
	Verify that the values of temperatures have reached their work values. Both temperature indicators must be lit.
	If necessary, remove the layer of Blue-Cleaner from the PUR head.

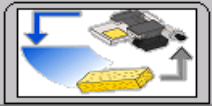
01		<p>Switch on the machine using the main switch. Turn the switch to the position ON.</p>
02		<p>Verify that the pressure in input, displayed on the input manometer, is correct. MIN 6 BAR</p>
03		<p>Open the valve on the pre-melting unit: The valve with the lever in vertical position indicates that it is open.</p>
04		<p>Verify the preset temperatures.</p>
05		<p>Wait for warm-up phase.</p>
06		<p>At the end of warming up the machine is running a series of cycles of opening and closing of the glue valve.</p>
07	<p>Press the BUTTON </p>	<p>Perform the procedure of glue restoring.</p>
08		<p>To produce a milled book, please adjust the milling depth.</p>
09		<p>To produce a not milled book, please use the lever for lowering the milling unit.</p>

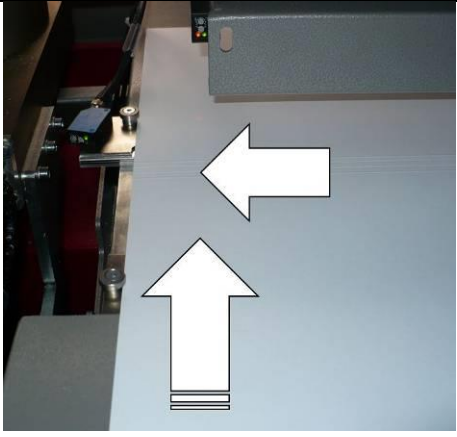
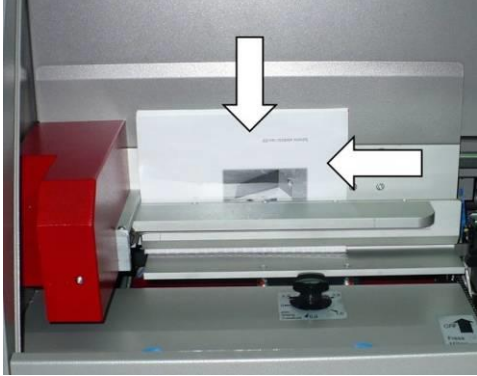
10		Insert the parameters of the thickness of the book, cover, front and rear glue stops.
11		Select the desired speed
12		Perform a general reset
13		Perform an axis positioning
14		Adjust the pressure of the glue
15		Adjust the pressure of the press
16		Place the cover over the press, placing it at the left fixed reference and the adjustable reference in the bottom of the press
17		Load the booklet in the clamp as shown by the arrow in the figure
18		Press the Start Button
19		The machine will close the clamp, and this will begin to move through the Milling Station and the glue unit, when the position will be achieved the press will apply the cover, and during the time of pressing the clamp will go back. When the yellow light will be lit it will be possible to withdraw the book.

18CLEANING THE MACHINE

When the machine work using PUR glue, it is imperative and essential an accurate cleaning of the glue.

The dried glue is no more refundable.

Residue of glue during the drying process can cause blockages or a uneven extrusion of the glue.

The glue group must be kept clean with the deposits of glue, PUR glue residues harden over time and cause damages to the equipment.

Performing the “End of job cleaning” it is possible to save the machine turned off containing PUR glue for 2 weeks.

COMPULSORY CLEANING for proper operation of the machine.

"If the machine is **switched off or unused for more than 120 minutes** it is necessary to make the cycle of "End of job cleaning".

EVERY DAY:

END OF JOB CLEANING

EMPTY THE CHIPS ASPIRATOR

ONCE IN THE WHEEK:

CLEANING SIDE EXTRUDER

CLEANING SPINE EXTRUDER



CLEANING DETAILS

In case of:

Some pages are not glued	Perform the spine extruder cleaning
The glue on the side is not uniform	Perform the side extruder cleaning

18.1 PROCEDURE TO CLEAN THE SPINE GLUE EXTRUDER.

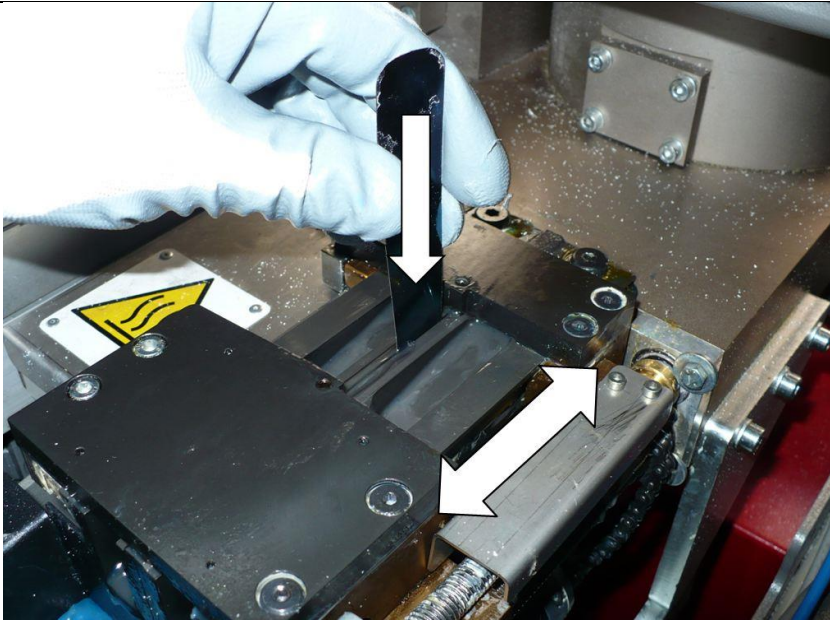
	<p>Press the Button “Manual movements”.</p>
	<p>Press the key dedicated to the glue head.</p>
	<p>Press reset to open the head up to the reset position</p>

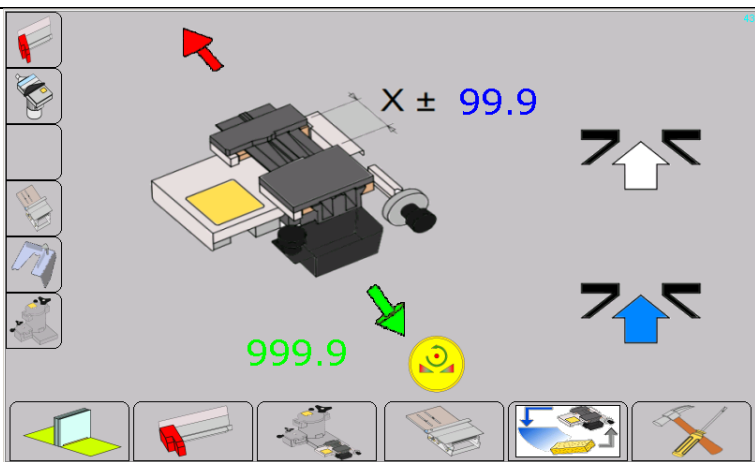
	<p>Insert the calibrated blade into the slot extrusion to touch the bottom and move it along the slot to remove or release any possible obstructions.</p>
	<p>Adjust the value of the glue extrusion pressure to 1bar.</p>
	<p>Hold the key “FUORIUSCITA COLLA” for few seconds until you do not see the glue spilling.</p> <p>Verify that the glue extrusion is uniform; otherwise, insert the calibrated blade and repeat the cleaning operation.</p> <p>The tank pressure will turn off after some minutes of inactivity.</p>



Thoroughly clean the blade.
When the glue is fully cured the blade will no longer operate.

18.2 PROCEDURE TO CLEAN THE GLUE SIDE EXTRUDERS.

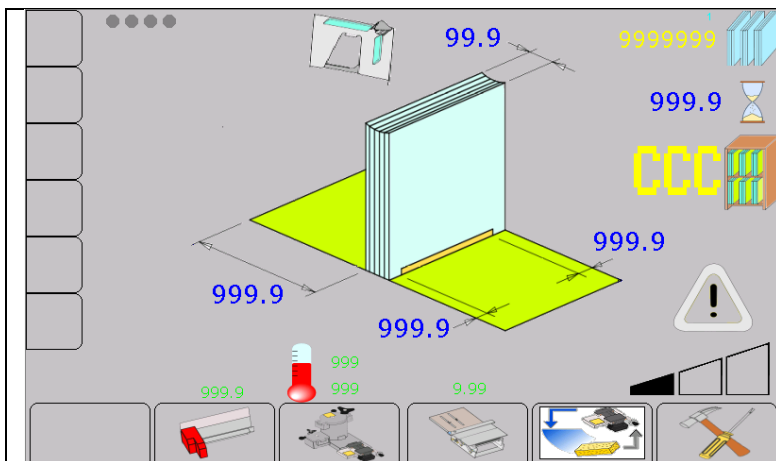



Press the Button “Manual movements”.



Press the key dedicated to the glue head

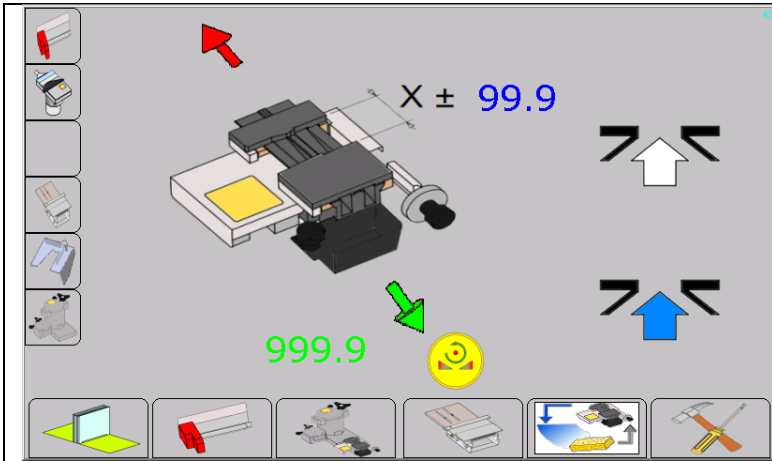



Press reset to open the head to the reset position. 

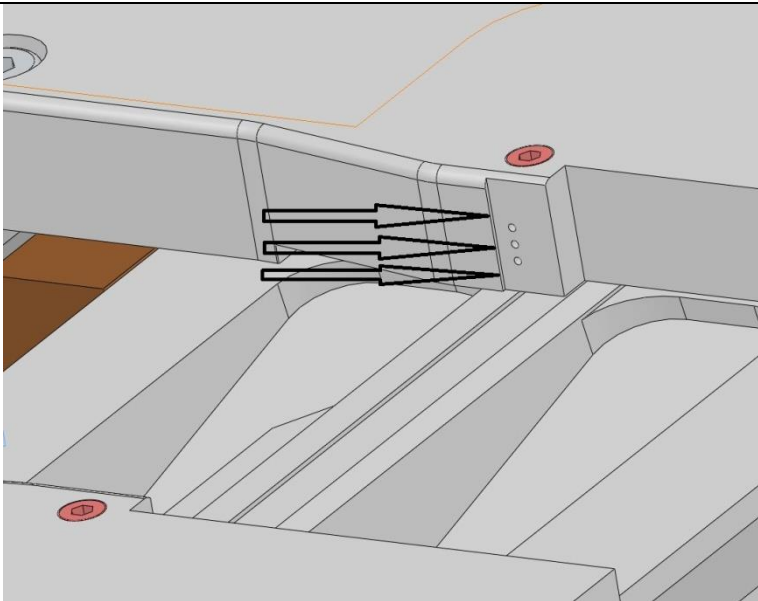

The glue smeared on the side of the book is extruded through 3 small channels located on the plates containing the book.

To get a correct extrusion of the side glue you must remove the headless screw and insert in the holes the included wire

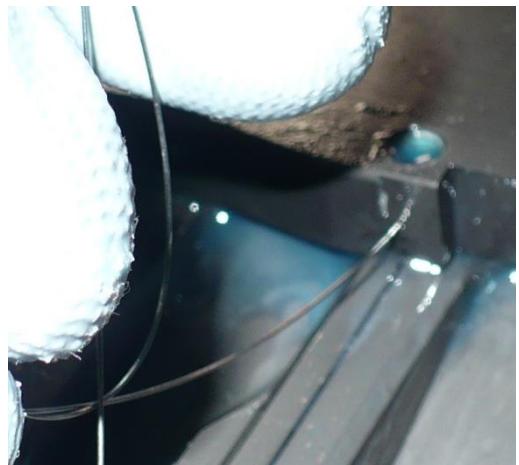
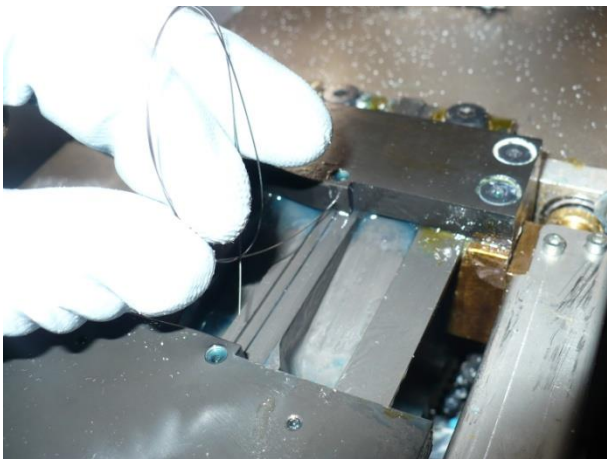

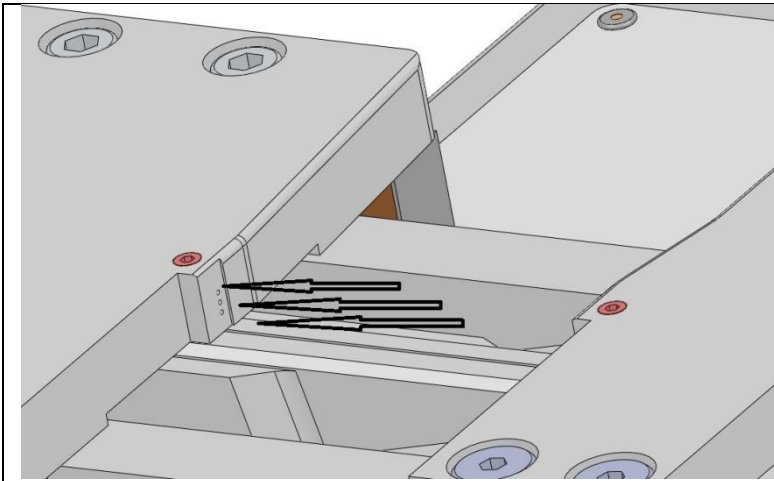

To get a correct extrusion of the side glue you must remove the headless screw and insert in the holes the included wire.

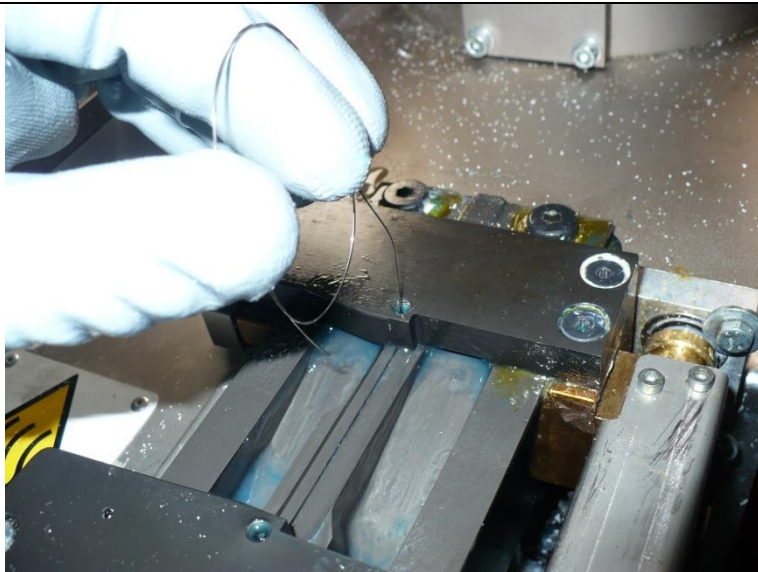

Pass the thread also in the main conduit until you enter into the below slot.

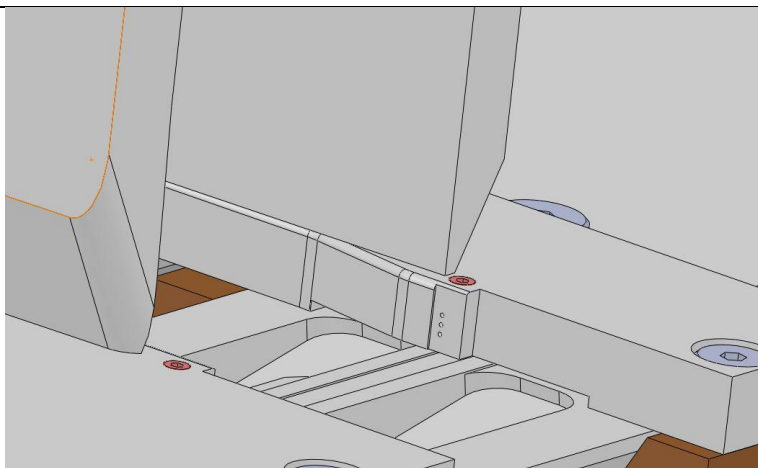
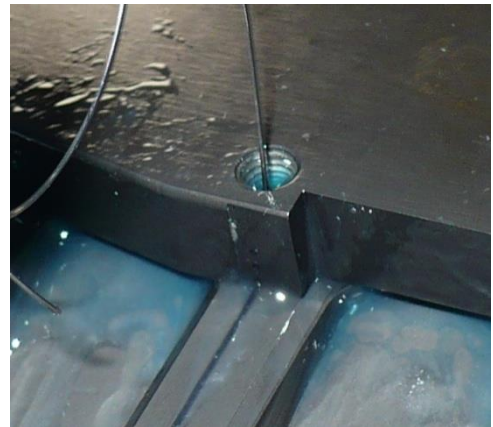

Be careful. When you replace the headless screws, they cannot protrude otherwise you cause a collision with the nipping station. Attention! Headless screws max. protrude 1 mm

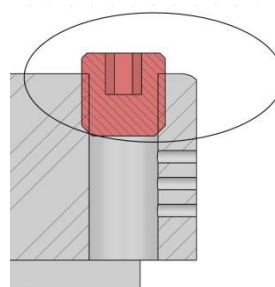

18.3“END OF JOB” CLEANING

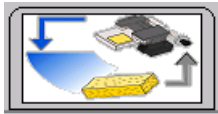
	<p>To switch off the machine at the end of the day you must eject the remaining glue inside of the extruder.</p> <p>To do it you must activate the automatic procedure that allows executing a safety off.</p> <p>Hold for a few seconds the BUTTON  to start the procedure.</p>
	<p>During this phase the glue group opens and the glue starts to exit.</p> <p>Use the green spatula included and make the glue to flow in the collection tank. Try to remove as much as possible of the released glue.</p> <p>Press OK</p>
	<p>Remove the headless screws using the included L wrench (Pay attention to the temperature).</p> <p>Press OK.</p>

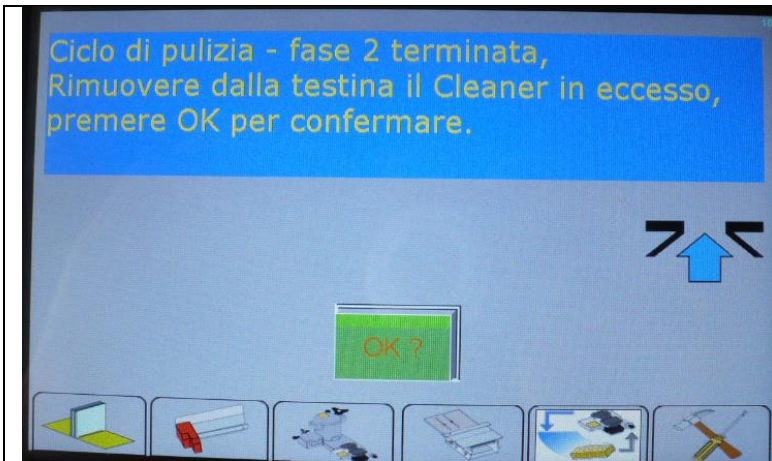

Press “Ancora Cleaner” until from the extruder exits only cleaner.

Press OK

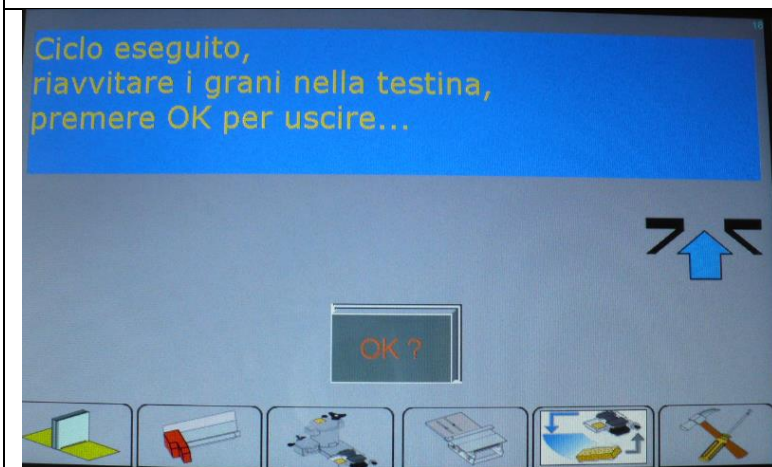

Screw the headless screws using the same included L wrench (Pay attention to the temperature).

Press OK.

The machine is now ready to be switched off..



Close the back valve.

The valve is closed when in horizontal position.

18.4 DETAILS CLEANING

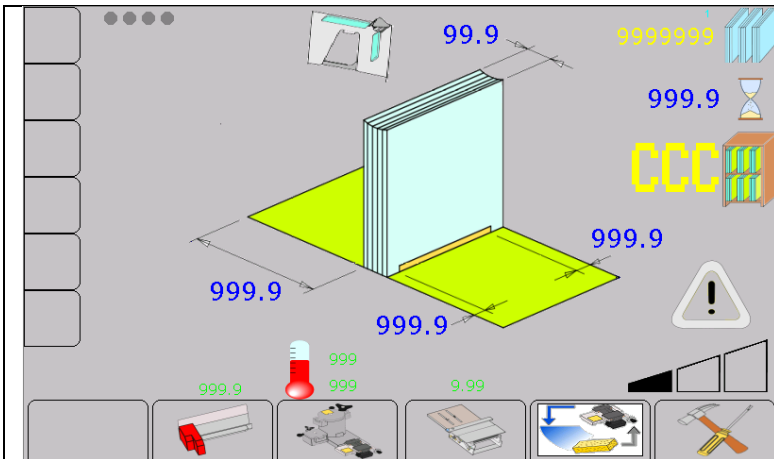

Press the Button “manual movements”

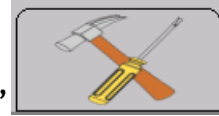

Press the head key

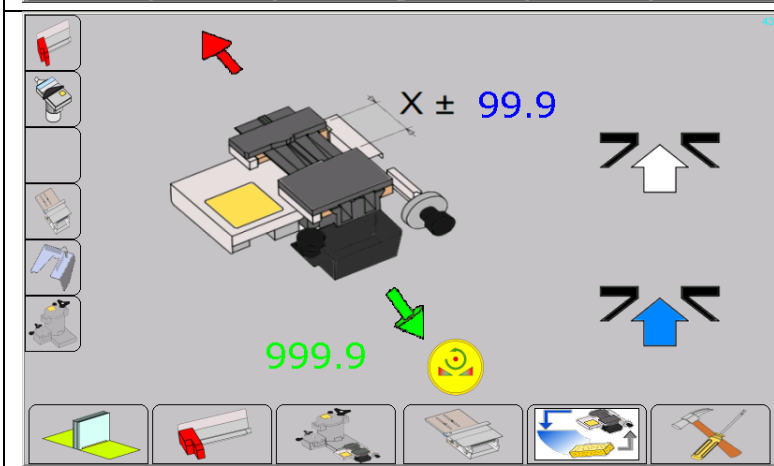

Press reset to make the head open to the reset position.





Adjust the glue extrusion pressure to 1 bar.

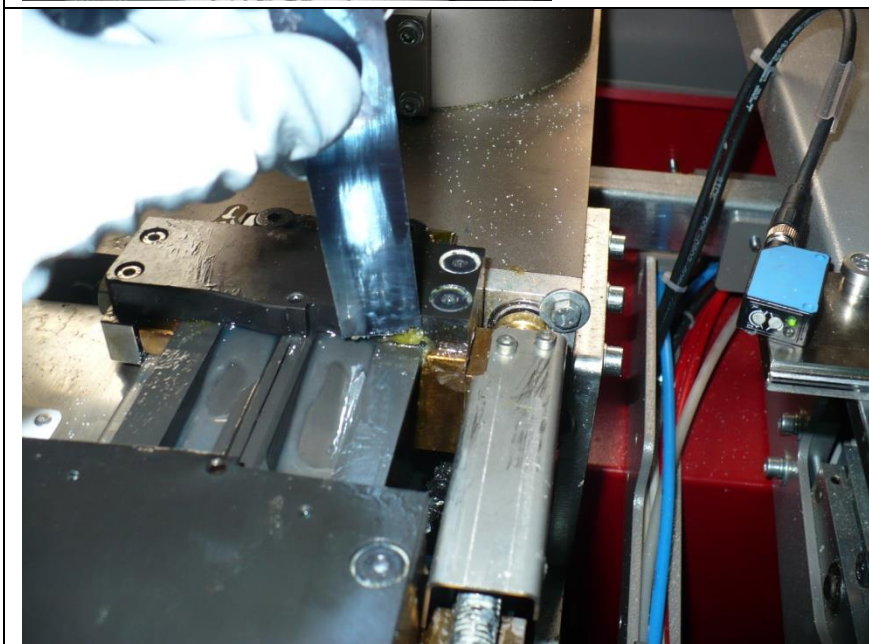

Use the included blade to remove all the visible glue traces.

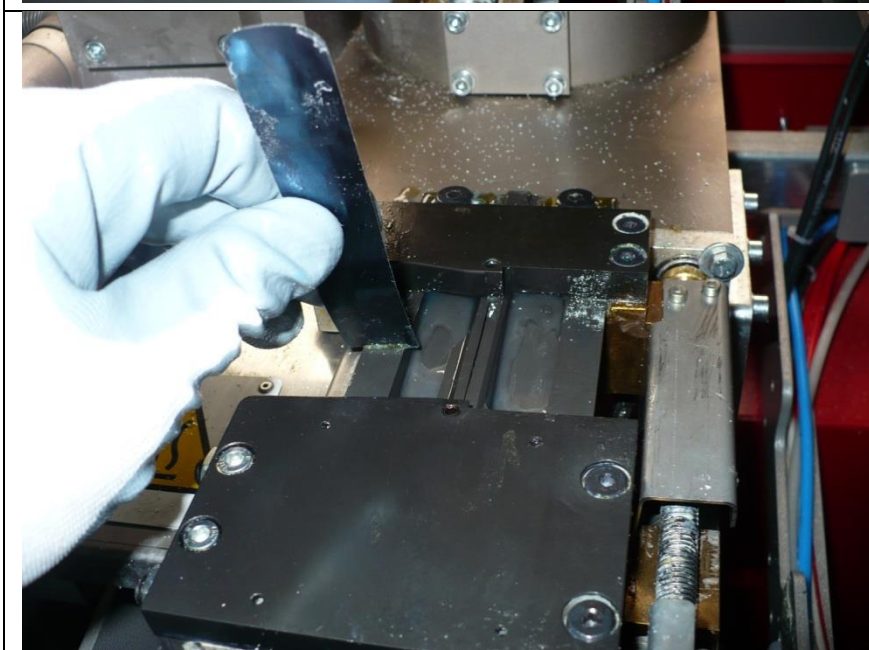



If necessary you can use liquid solvents to get a better cleaning of the surface.

During the use of liquid solvents refer to the safety instructions provided by the solvent manufacturer.



Clean carefully all the used tools, otherwise they become unusable later.

19 Problems - Solutions

19.1 CHIPS ASPIRATOR - LESS VACUUM:

- Verify that the plexiglass inspection, located on the Milling Station, is free.
- Verify that the chips aspirator tank is empty.
- Verify that the chips aspirator tube is not full of chips.
- Verify that the aspirator filter is clean.

19.2 CLAMP - IT DOES'T START:

- Verify the presence of a book.
- Verify that the emergency switch is disabled.
- Verify that the barrier light is completely free.
- Verify that the book detecting photocell and the related reflector are clean.
- Verify that the photocell or the reflector of the press is free from books, pieces of paper or dust.
- Verify that the clamp jaws are free from glue residues.
- Verify the air pressure in the machine.

19.3 IRREGULAR GLUE START / STOP :

- Clean the photocell and the reflector positioned between the silent plane and the Milling Station.

19.4 MILLING STATION - IRREGULAR CUT AND NOTCHING:

- Verify that the Milling disk is not broken or damaged. This could happen by the management of books already bound with glue (TO AVOID).

19.5 COVER PLATE MILLING STATION - IT DOES'T OPEN / CLOSE CORRECTLY:

- Remove the 4 screws by using a wrench. Remove the cover plate Milling Station releasing the strap. Clean inside of the milling station box.
- Shorten the strap by a node close to the interior of the Milling Station box, increasing the strength of the plate closure.

19.6 HEAD - OUT OF TOO MUCH OR LITTLE GLUE:

- Verify the air pressure of the glue group.
- Verify that the head shutter is free, using the provided blade.
- Verify that the side holes are free, using the provided steel wire.
- Verify that the injectors are working properly (they must move back and forth 3-4 mm).
- Verify the glue presence in the tank.
- Verify that the glue in the tank is not hard-gel.
- Verify that the tank valve is open.
- Verify the position of the internal lateral jaw: it must be 0.10 tenths back from the edge of the clamp.

- Verify the head height: if it comes out a little glue lower the head and increase the air pressure of the glue group, if it comes out to much glue raise the head and lower the air pressure of the glue.

22.7 PRESS

- Press so much: lower the air pressure of the press group or the spine height.
- Round spine: increase the press height.
- Edge pinched: contact technical support.
- Not uniform spine: contact technical support.